

# CP<sup>®</sup> NOZZLES

Get the Drop to the Crop

## 2024 CP Ground Nozzles Catalog

**CP109-LS**  
Low Volume Floater Nozzle

Speed(MPH)   
Spacing   
Desire GPA

Tip - Orifice	Estimate of Pressure Needed	Classification
#7.5 Tip - 5 Orifice	45	VC
#18 Tip - 7.5 Orifice	20	XC
#7.5 Tip - 7.5 Orifice	38	
#7.5 Tip - 10 Orifice	21	
#7.5 Tip - 15 Orifice	21	

### CP Quick Calculator

The CP Quick Calculator is a free tool for choosing which products and set-ups will work the best for different jobs.

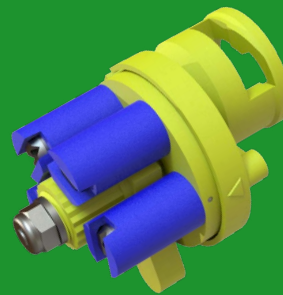
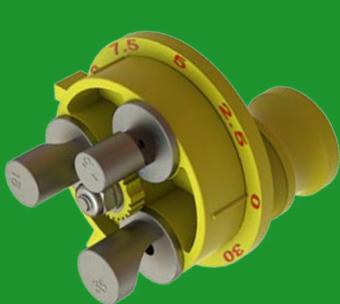

# CP<sup>®</sup> NOZZLES



## Options for Contact Fungicide.



CP-65T-SL has 5 Orifice/Tip settings.  
CP-74 Q has 6 Tip Options.  
CP-65T-S has 2 Orifice/Tip settings.

## Options for Systemic Fungicide.



CP-65T-SL has 7 Orifice/Tip settings.  
CP-74 Q has 13 Tip Options.  
CP-65T-S has 2 Orifice/Tip settings.  
CP-65T-SHP has 1 Orifice/Tip setting.

## Options for Contact Insecticide.



CP-65T-SL has 7 Orifice/Tip settings.  
CP-74 Q has 15 Tip Options.  
CP-65T-S has 3 Orifice/Tip settings.  
CP-65T-SHP has 2 Orifice/Tip settings.

## Options for Systemic Insecticide.



CP-65T-SL has 9 Orifice/Tip settings.  
CP-74 Q has 14 Tip Options.  
CP-65T-S has 10 Orifice/Tip settings.  
CP-65T-SHP has 4 Orifice/Tip settings.

## Options for Post-Emerg Contact Herbicide.



CP-59LS/CP-109LS has 6 Orifice/Tip settings.  
CP-55R3/CP-102R3 2 has Orifice/Tip settings.  
CP-55HV/CP-109HV has 7 Orifice/Tip settings.

## Options for Post-Emerg Systemic Herbicide.



CP-59LS/CP-109LS has 10 Orifice/Tip settings.  
CP-55R3/CP-102R3 8 has Orifice/Tip settings.  
CP-55HV/CP-109HV has 14 Orifice/Tip settings.

## Options for Post-Emerg Herbicide.



CP-59LS/CP-109LS has 10 Orifice/Tip settings.  
CP-55R3/CP-102R3 8 has Orifice/Tip settings.  
CP-55HV/CP-109HV has 14 Orifice/Tip settings.

SPRAYERS

FLOATERS

# Table of Contents

<b>Floater Nozzles (Pre-Emerge)</b>	<b>1</b>
<b>Combo Nozzles with Check Valves</b>	<b>5</b>
<b>Sprayer Turbo Nozzles (Post Emerge)</b>	<b>13</b>
<b>Check Valves</b>	<b>19</b>
<b>Spray Accessories</b>	<b>23</b>
<b>Tip Options</b>	<b>25</b>
<b>Technical Data &amp; Reference Charts</b>	<b>28</b>
<b>CP Nozzles Setup, Use &amp; Maintenance</b>	<b>45</b>
<b>Quick List of Products</b>	<b>46</b>
<b>Quick List of Replacement Parts</b>	<b>47</b>

## Why **CP**<sup>®</sup> **NOZZLES**?

### Want to Eliminate the Need for All the Tips?

Changing tips is time-consuming and frustrating when application windows are limited and you need spraying done quickly. CP<sup>®</sup> Nozzles have orifices and deflectors, allowing applicators to dial in the flow rate and the droplet sizes needed —taking two minutes instead of twenty. With spraying time worth several hundred dollars an hour, the savings add up quickly.

CP<sup>®</sup> Check Valves incorporate a simple needle/seat design. There are no traditional type diaphragms to change. As a result, the check valve will not open when traveling from field to field or while the rig is parked. All the applicator usually needs to do is pull the stem to stop most drips or clear debris from orifices. This allows debris to flush from the nozzle. CP<sup>®</sup> Combos are selectable floater nozzles with built-in check valves. They provide the advantages of both CP's nozzles and check valves.

### Not Changing Tips Very Often?

Field and drift conditions—muddy ground, uneven terrain, weather and wind changes— dictate the need for different speeds and droplet sizes. Being able to change orifices and deflectors allows applicators to adjust quickly to differing field conditions. The ease of changing from one setting to another makes it more likely the proper set-up is used when the pressure to keep spraying is intense, and field conditions change.

Chemical exposure is always a concern. Because there are no tips to handle and no buckets of tips in the cab, applicators using CP<sup>®</sup> Nozzles have limited contact with contaminated parts. CP<sup>®</sup> Check Valves and Combos help prevent chemical contact by allowing most drips and clogged nozzles to be cleared by a pull of the stem.

CP<sup>®</sup> Nozzles is a division of Transland. Please visit [Translandllc.com](http://Translandllc.com) for warranty information. For online information about the ground nozzles. Visit [www.GroundNozzles.com](http://www.GroundNozzles.com).





# Floater Nozzles (Pre-Emerge)

Floater nozzles work well for small grain, pastures, and hayfields.

CP's Floater Turbo Nozzles with Poly Selector and 3 Stainless Steel Deflector Tips are designed for conditions where drift is a concern. These nozzles are excellent pre-emerge nozzles. All versions have flood nozzle flow rates and generate consistent large droplets with few driftable fines. Each deflector tip covers specific orifices for proper coverage, i.e., the smallest tip covers the smallest two orifices, the middle tip the middle three orifices, and the largest tip the largest three orifices. Change rates quickly without carrying buckets of tips; turn the dial and keep working. All Floater Nozzle parts are replaceable. Use the CP Quick Calc to find suggested settings for the nozzles.

## CP-59LS Low Volume Floater Turbo Nozzle

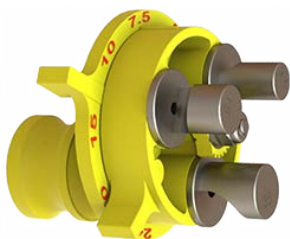

- GPM range of .43 to 6.71
- Poly body with quick coupler adaptors attaches to 3/4" cam couplers
- Poly Eight Orifice Selector: 2.5, 5, 7.5, 10, 15, 20, 24, 30
- Stainless Steel Deflector Tips: 7.5, 18, and 35 are the standard tips used with this Nozzle; however, customers can choose from other available tip sizes to work with the Nozzle. *Note: Any deflector tip can be used with any orifice. However, the maximum flow rate for any orifice can be no greater than the rate of the deflector tip.*
- Works with 30", 40", and 60" spacing
- Mounting is recommended for 60" centers or less. Orientation should be between 0° and 45° upward of ground parallel.
- Operating pressures are between 30 to 50 psi

## CP-59HV High Volume Floater Turbo Nozzle



- GPM range of .87 to 13.42
- Poly body with quick coupler adaptors attaches to 3/4" cam couplers
- Poly Eight Orifice Selector: 5, 10, 15, 20, 30, 40, 50, and 60
- Stainless Steel Deflector Tips: 12, 35, and 60HV are the standard tips used with this Nozzle; however, customers can choose from other available tip sizes to work with the Nozzle. *Note: Any deflector tip can be used with any orifice. However, the maximum flow rate for any orifice can be no greater than the rate of the deflector tip.*
- Works with 30", 40", and 60" spacing
- Mounting is recommended for 60" centers or less. Orientation should be between 0° and 45° upward of ground parallel.
- Operating pressures are between 30 to 50 psi

## CP-55R3 Regular Volume Floater 3-Way Nozzle



CP's Regular Volume Floater Nozzle with Stainless Steel Selector and 3-Way Deflector works like the other floater nozzles. This stainless steel nozzle is ideal for heavy slurry applications. Each deflector angle covers specific orifices for proper coverage, i.e., the S angle covers the smallest two orifices, the M angle the middle three orifices, and the L angle the three largest orifices.

- GPM range of .50 to 12.00
- Poly body with quick coupler adaptors attaches to 3/4" cam couplers
- Stainless Steel Eight Orifice Selector: 5, 10, 15, 20, 30, 40, 50, and 60
- Stainless Steel 3-Way Deflector
- Mounting is recommended for 60" centers or less. Orientation should be between 0° and 45° upward of ground parallel.
- Operating pressures are between 10 and 60 psi





**Change  
Flow  
Rates or  
Droplet  
Sizes  
with a  
Turn  
of the  
Dial!**

# How It Works

Turn Deflector Tip Wheel Handle into place desired for tip size.

Turn Selector Handle to click into place desired for orifice size.

**Use the flow chart provided by CP Nozzles to find the Orifice/Tip combination to produce the desired GPM.**

Multiple tip sizes are available to further customize the nozzle.

# CP-59LS – Replacement Parts

Low Volume Floater Turbo

Stainless Steel Standard Tips 7.5, 18 & 35 (Custom Tips Available Upon Request)

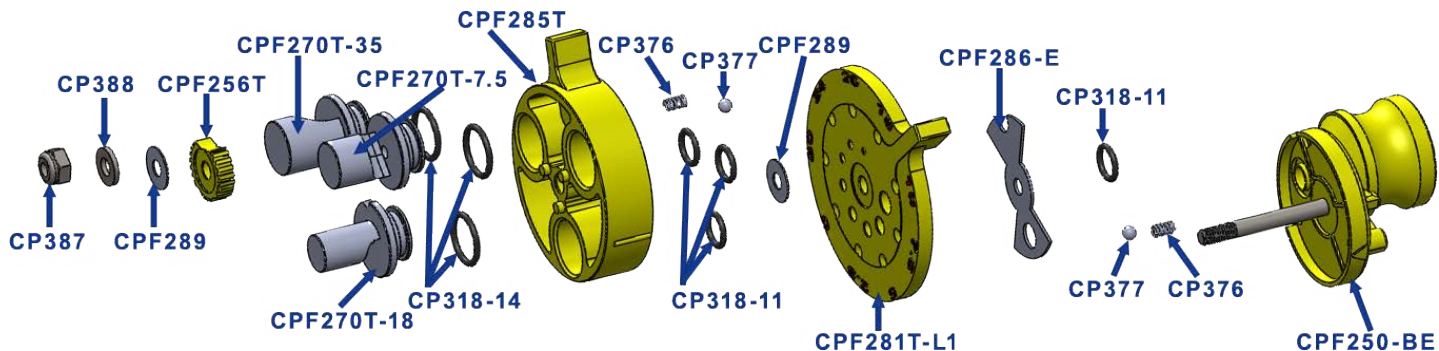

Custom Tip PN	Description
CPF270T-60HV	SS Turbo Floater Tip - #60HV
CPF270T-60	SS Turbo Floater Tip - #60
CPF270T-15	SS Turbo Floater Tip - #15
CPF270T-12	SS Turbo Floater Tip - #12
CPF270T-10	SS Turbo Floater Tip - #10

Custom Tip PN	Description
CPF270T-5ST	Turbo Floater Tip - 5 Straight Stream
CPF270T-5	SS Turbo Floater Tip - #5
CPF270T-3ST	SS Turbo Floater Tip - 3 Stream
CPF270T-3HV	SS Turbo Floater Tip - 3 Stream High Volume

# CP-59HV – Replacement Parts

High Volume Floater Turbo

Stainless Steel Standard Tips 12, 35 & 60HV (Custom Tips Available Upon Request)

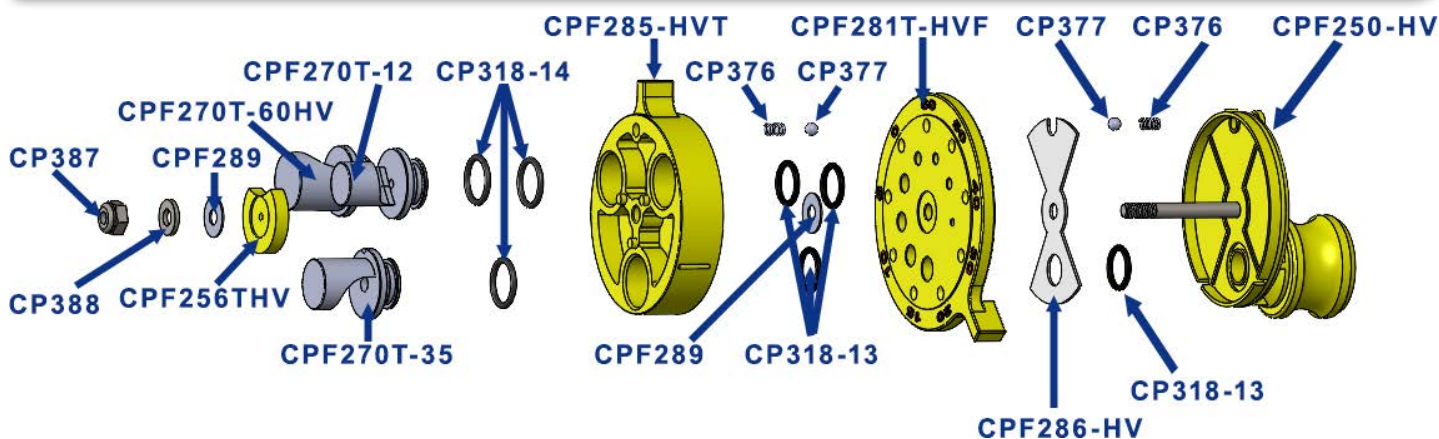

Custom Tip PN	Description
CPF270T-60	SS Turbo Floater Tip - #60
CPF270T-18	SS Turbo Floater Tip - #18
CPF270T-15	SS Turbo Floater Tip - #15
CPF270T-10	SS Turbo Floater Tip - #10
CPF270T-7.5	SS Turbo Floater Tip - #7.5

Custom Tip PN	Description
CPF270T-5ST	Turbo Floater Tip - 5 Straight Stream
CPF270T-5	SS Turbo Floater Tip - #5
CPF270T-3ST	SS Turbo Floater Tip - 3 Stream
CPF270T-3HV	SS Turbo Floater Tip - 3 Stream High Volume

# CP-55R3 — Replacement Parts

Regular Volume Floater

Stainless Steel 3-Way Deflector

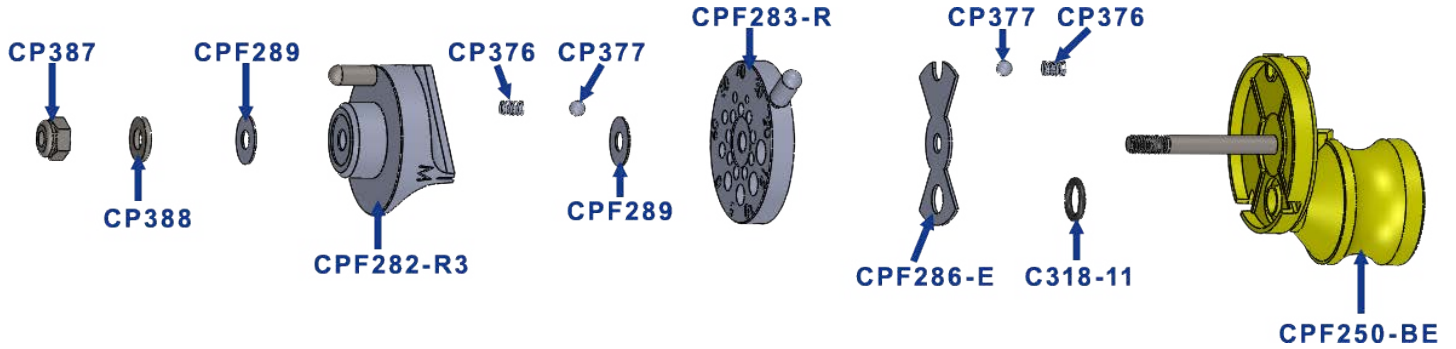

## CP Adaptor for Certified Tips



*Take any quarter-turn certified tip and mount it onto the CP-59LS, CP-59 HV, CP-109LS, CP-109HV, CP-109LS-AS, and CP-109HV-AS nozzle body.*

*This process takes less than a minute! See page 24 for details.*



# Combo Nozzles with Check Valves

CP's Floater Turbo Combo Nozzles with Poly Selector and 3 Stainless Steel Deflector Tips with Built-in Check Valve reduce parts on the boom. This combo nozzle is designed for conditions where drift is a concern, making this combo an excellent pre-emerge application nozzle. All versions have flood nozzle flow rates and generate consistent large droplets with few driftable fines. Each deflector tip covers specific orifices for proper coverage, i.e., the smallest tip covers the smallest two orifices, the middle tip the middle three orifices, and the largest tip the largest three orifices. Change rates quickly without carrying buckets of tips; turn the dial and keep working. All parts are replaceable. Use the CP Quick Calc to find suggested settings for nozzle.

## CP-109LS Low Volume Floater Turbo Combo Nozzle



- GPM range of .43 to 6.71
- Poly body with quick coupler adaptors attaches to 3/4" cam couplers and built-in Check Valve
- Poly Eight Orifice Selector: 2.5, 5, 7.5, 10, 15, 20, 24, 30
- Stainless Steel Deflector Tips: 7.5, 18, and 35 are the standard tips used with this Nozzle; however, customers can choose from other available tip sizes to work with the Nozzle. *Note: Any deflector tip can be used with any orifice. However, the maximum flow rate for any orifice can be no greater than the rate of the deflector tip.*
- Mounting is recommended for 60" centers or less. Orientation should be between 0° and 45° upward of ground parallel.
- Operating pressures are between 30 and 50 psi

## CP-109HV High Volume Floater Turbo Combo Nozzle



- GPM range of .87 to 13.42
- Poly body with quick coupler adaptors attaches to 3/4" cam couplers and built-in Check Valve
- Poly Eight Orifice Selector: orifice sizes 5, 10, 15, 20, 30, 40, 50, and 60
- Stainless Steel Deflector Tips: 12, 35, and 60HV are the standard tips used with this Nozzle; however, customers can choose from other available tip sizes to work with the Nozzle. *Note: Any deflector tip can be used with any orifice. However, the maximum flow rate for any orifice can be no greater than the rate of the deflector tip.*
- Mounting is recommended for 60" centers or less. Orientation should be between 0° and 45° upward of ground parallel.
- Operating pressures are between 10 and 60 psi

## CP-109LS-AS Low Volume Floater Turbo Combo Air Stop Nozzle

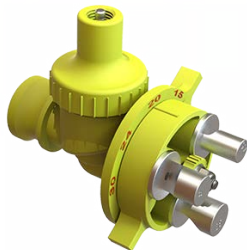

- GPM range of .43 to 6.71
- Poly body with quick coupler adaptors attaches to 3/4" cam couplers and built-in Air Stop Check Valve
- Poly Eight Orifice Selector: orifice sizes 2.5, 5, 7.5, 10, 15, 20, 24, 30
- Stainless Steel Deflector Tips: 7.5, 18, and 35 are the standard tips used with this Nozzle; however, customers can choose from other available tip sizes to work with the Nozzle. *Note: Any deflector tip can be used with any orifice. However, the maximum flow rate for any orifice can be no greater than the rate of the deflector tip.*
- Mounting is recommended for 60" centers or less. Orientation should be between 0° and 45° upward of ground parallel.
- Operating pressures are between 30 to 50 psi

## CP-109HV-AS High Volume Floater Turbo Combo Air Stop Nozzle



- GPM range .87 to 13.42
- Poly body with quick coupler adaptors attaches to 3/4" cam couplers and built-in Air Stop Check Valve
- Poly Eight Orifice Selector: orifice sizes 2.5, 5, 7.5, 10, 15, 20, 24, 30
- Stainless Steel Deflector Tips: 7.5, 18, and 35 are the standard tips used with this Nozzle; however, customers can choose from other available tip sizes to work with the Nozzle. *Note: Any deflector tip can be used with any orifice. However, the maximum flow rate for any orifice can be no greater than the rate of the deflector tip.*
- Mounting is recommended for 60" centers or less. Orientation should be between 0° and 45° upward of ground parallel.
- Operating pressures are between 10 and 60 psi

## CP-102R3 Regular Volume Floater 3Way Combo Nozzle



- GPM range of .5 to 12.00
- Poly body with quick coupler adaptors attaches to 3/4" cam couplers and built-in Check Valve
- Stainless Steel Eight Orifice Selector: 5, 10, 15, 20, 30, 40, 50, and 60
- Stainless Steel 3-Way Deflector
- Mounting is recommended for 60" centers or less. Orientation should be between 0° and 45° upward of ground parallel.
- Operating pressures are between 30 to 50 psi

**Reduce  
Parts on  
the Boom  
with a  
Built in  
Check  
Valve  
Combo  
Nozzle**



# CP-109LS – Replacement Parts

Low Volume Floater Turbo Combo Nozzle

Stainless Steel Standard Tips 7.5, 18, and 35 (Custom Tips Available Upon Request)

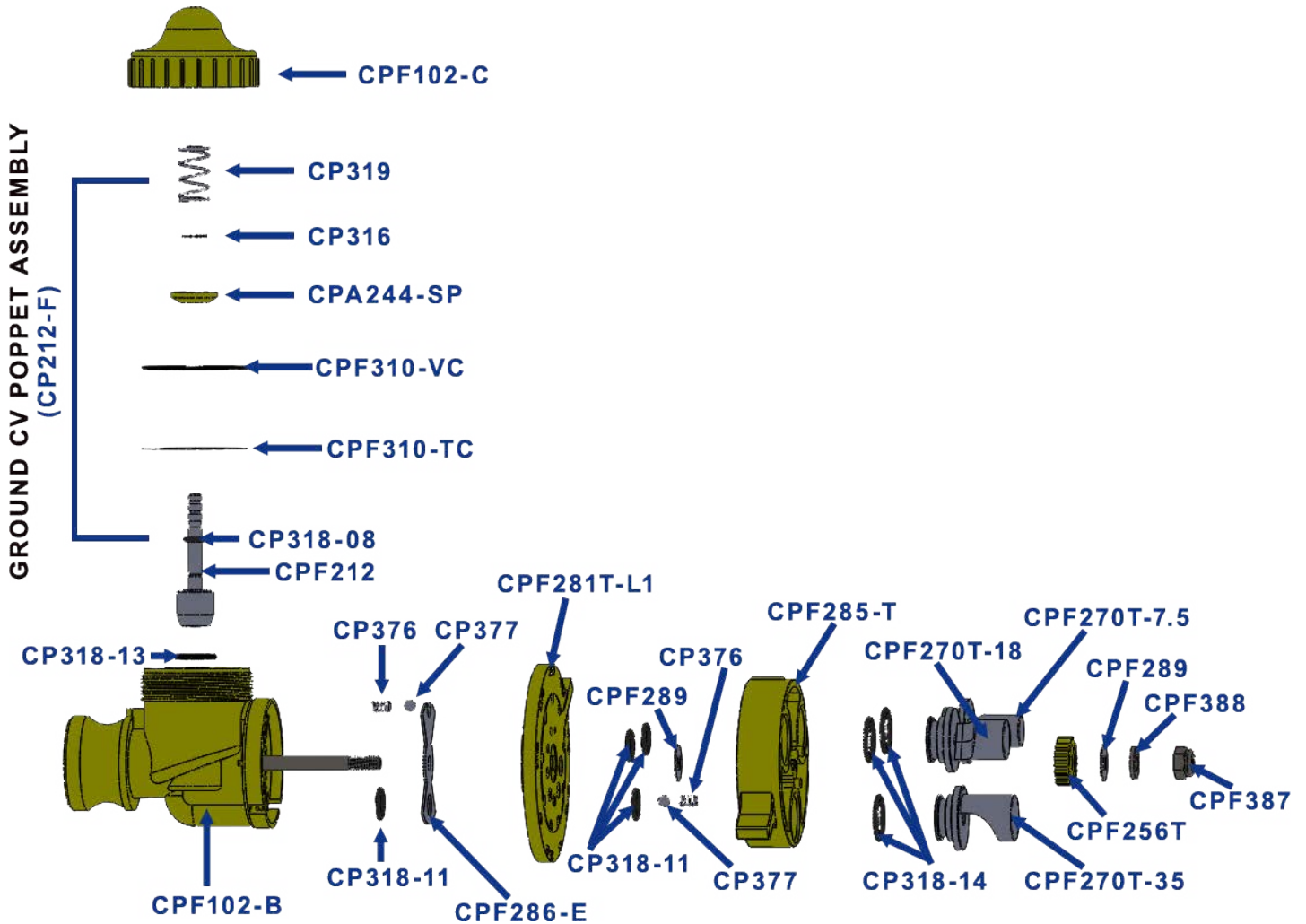

Custom Tip PN	Description
CPF270T-60HV	SS Turbo Floater Tip - #60HV
CPF270T-60	SS Turbo Floater Tip - #60
CPF270T-15	SS Turbo Floater Tip - #15
CPF270T-12	SS Turbo Floater Tip - #12
CPF270T-10	SS Turbo Floater Tip - #10

Custom Tip PN	Description
CPF270T-5ST	Turbo Floater Tip - 5 Straight Stream
CPF270T-5	SS Turbo Floater Tip - #5
CPF270T-3ST	SS Turbo Floater Tip - 3 Stream
CPF270T-3HV	SS Turbo Floater Tip - 3 Stream High Volume



# CP-109HV – Replacement Parts

High Volume Floater Turbo Combo Nozzle

Stainless Steel Standard Tips 12, 35, and 60HV (Custom Tips Available Upon Request)

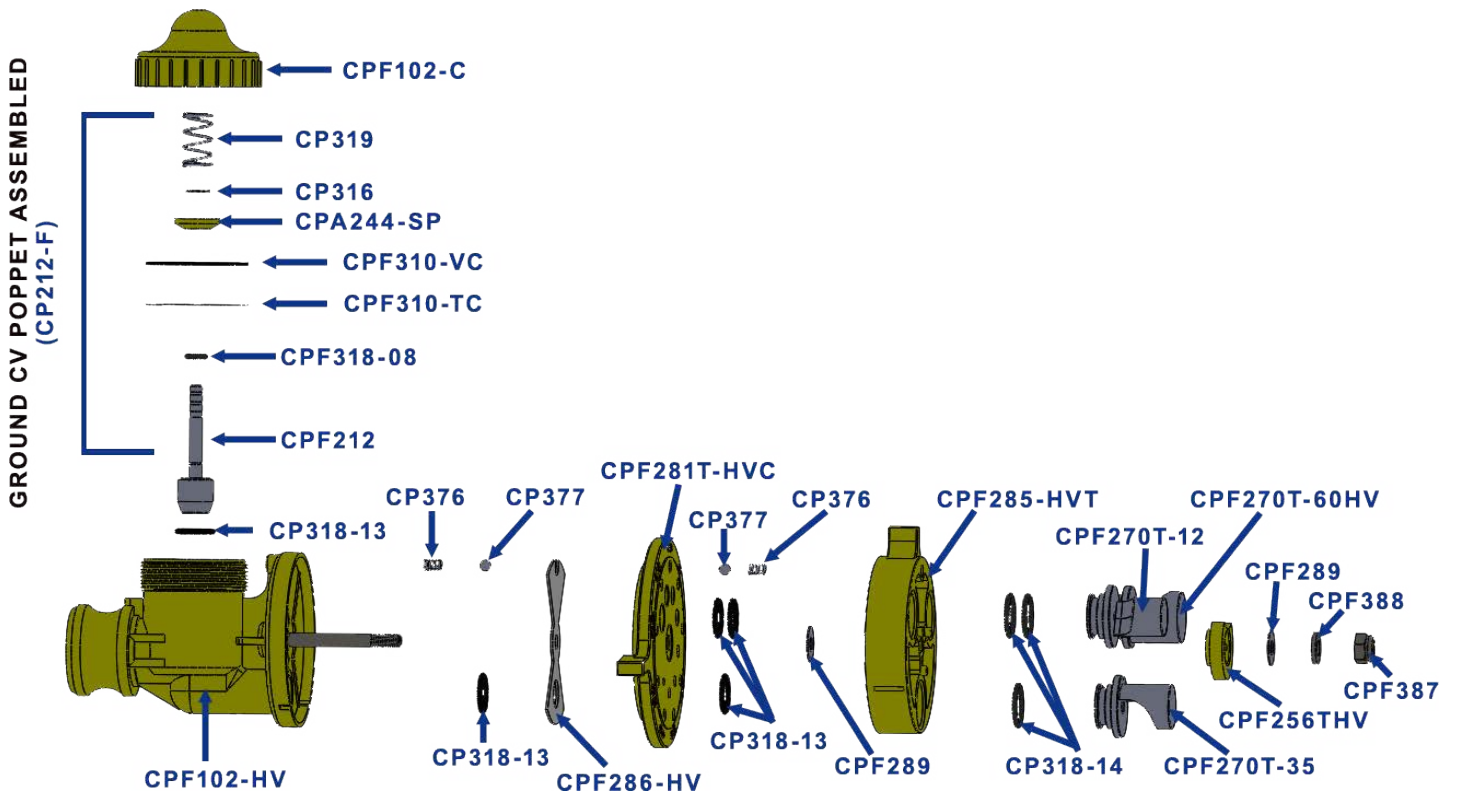

Custom Tip PN	Description
CPF270T-60	SS Turbo Floater Tip - #60
CPF270T-18	SS Turbo Floater Tip - #18
CPF270T-15	SS Turbo Floater Tip - #15
CPF270T-10	SS Turbo Floater Tip - #10
CPF270T-7.5	SS Turbo Floater Tip - #7.5

Custom Tip PN	Description
CPF270T-5ST	Turbo Floater Tip - 5 Straight Stream
CPF270T-5	SS Turbo Floater Tip - #5
CPF270T-3ST	SS Turbo Floater Tip - 3 Stream
CPF270T-3HV	SS Turbo Floater Tip - 3 Stream High Volume

# CP-109LS-AS – Replacement Parts

Low Volume Floater Turbo Combo Nozzle with Air Stop Check Valve

Stainless Steel Tips Standard Tips 7.5, 18, and 35 (Custom Tips Available Upon Request)

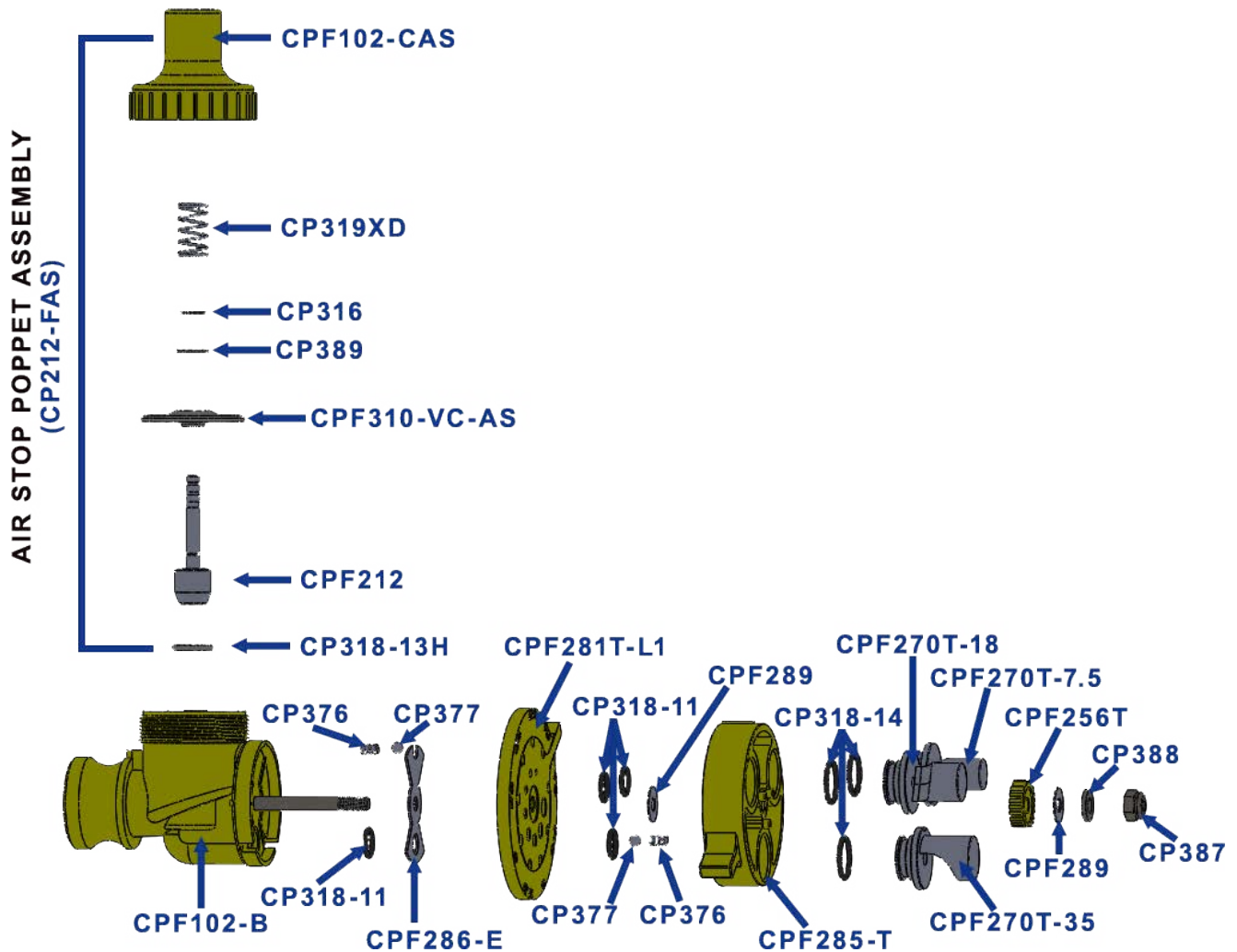

Custom Tip PN	Description
CPF270T-60HV	SS Turbo Floater Tip - #60HV
CPF270T-60	SS Turbo Floater Tip - #60
CPF270T-15	SS Turbo Floater Tip - #15
CPF270T-12	SS Turbo Floater Tip - #12
CPF270T-10	SS Turbo Floater Tip - #10

Custom Tip PN	Description
CPF270T-5ST	Turbo Floater Tip - 5 Straight Stream
CPF270T-5	SS Turbo Floater Tip - #5
CPF270T-3ST	SS Turbo Floater Tip - 3 Stream
CPF270T-3HV	SS Turbo Floater Tip - 3 Stream High Volume

# CP-109HV-AS – Replacement Parts

High Volume Floater Turbo Combo Nozzle with Air Stop Check Valve

Stainless Steel Standard Tips 12, 35, and 60 (Custom Tips Available Upon Request)

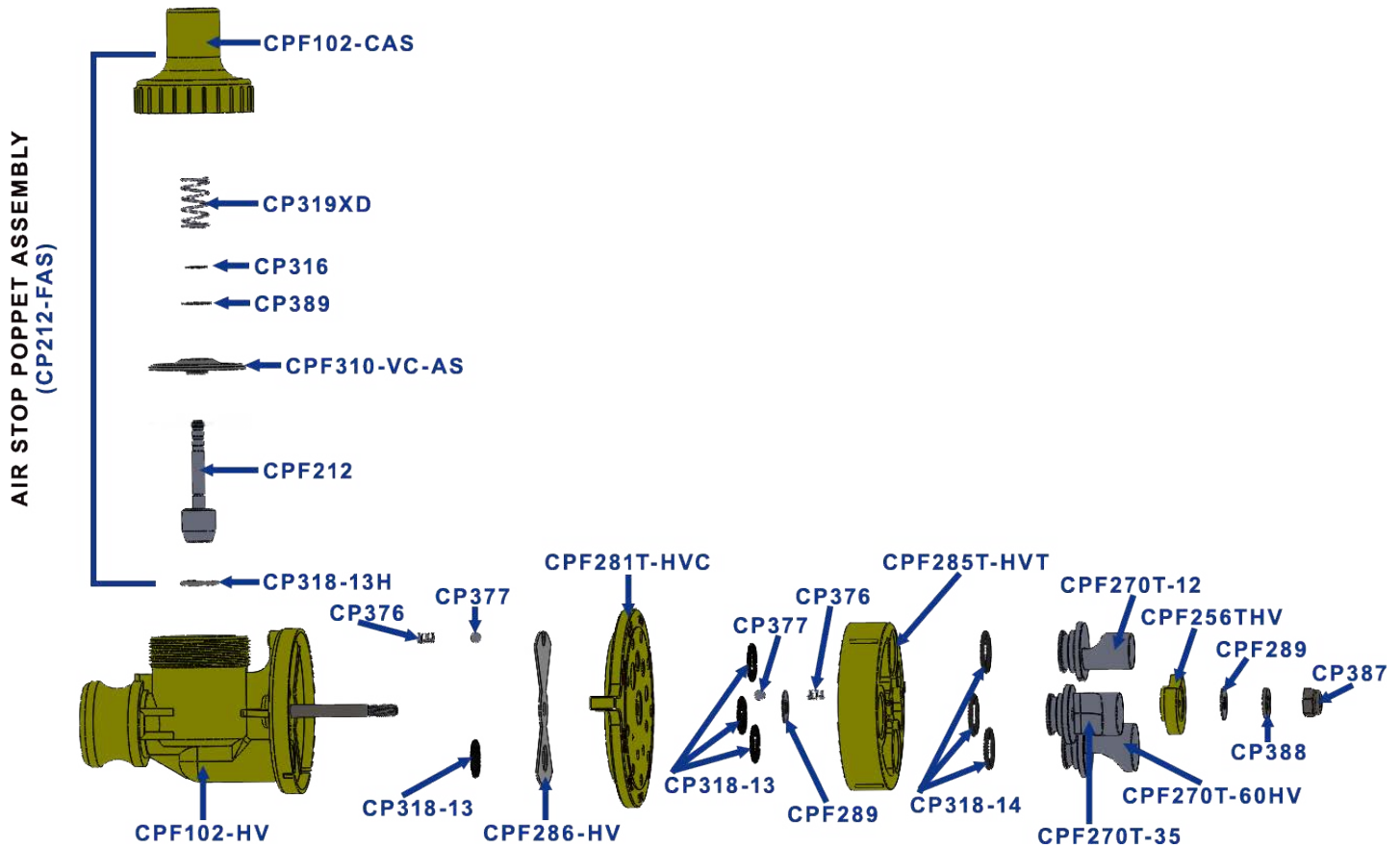

Custom Tip PN	Description
CPF270T-60HV	SS Turbo Floater Tip - #60HV
CPF270T-18	SS Turbo Floater Tip - #18
CPF270T-15	SS Turbo Floater Tip - #15
CPF270T-10	SS Turbo Floater Tip - #10
CPF270T-7.5	SS Turbo Floater Tip - #7.5

Custom Tip PN	Description
CPF270T-5ST	Turbo Floater Tip - 5 Straight Stream
CPF270T-5	SS Turbo Floater Tip - #5
CPF270T-3ST	SS Turbo Floater Tip - 3 Stream
CPF270T-3HV	SS Turbo Floater Tip - 3 Stream High Volume



# CP-102R3 – Replacement Parts

Regular Volume Floater 3-Way Combo Nozzle

Stainless Steel 3-Way Deflector

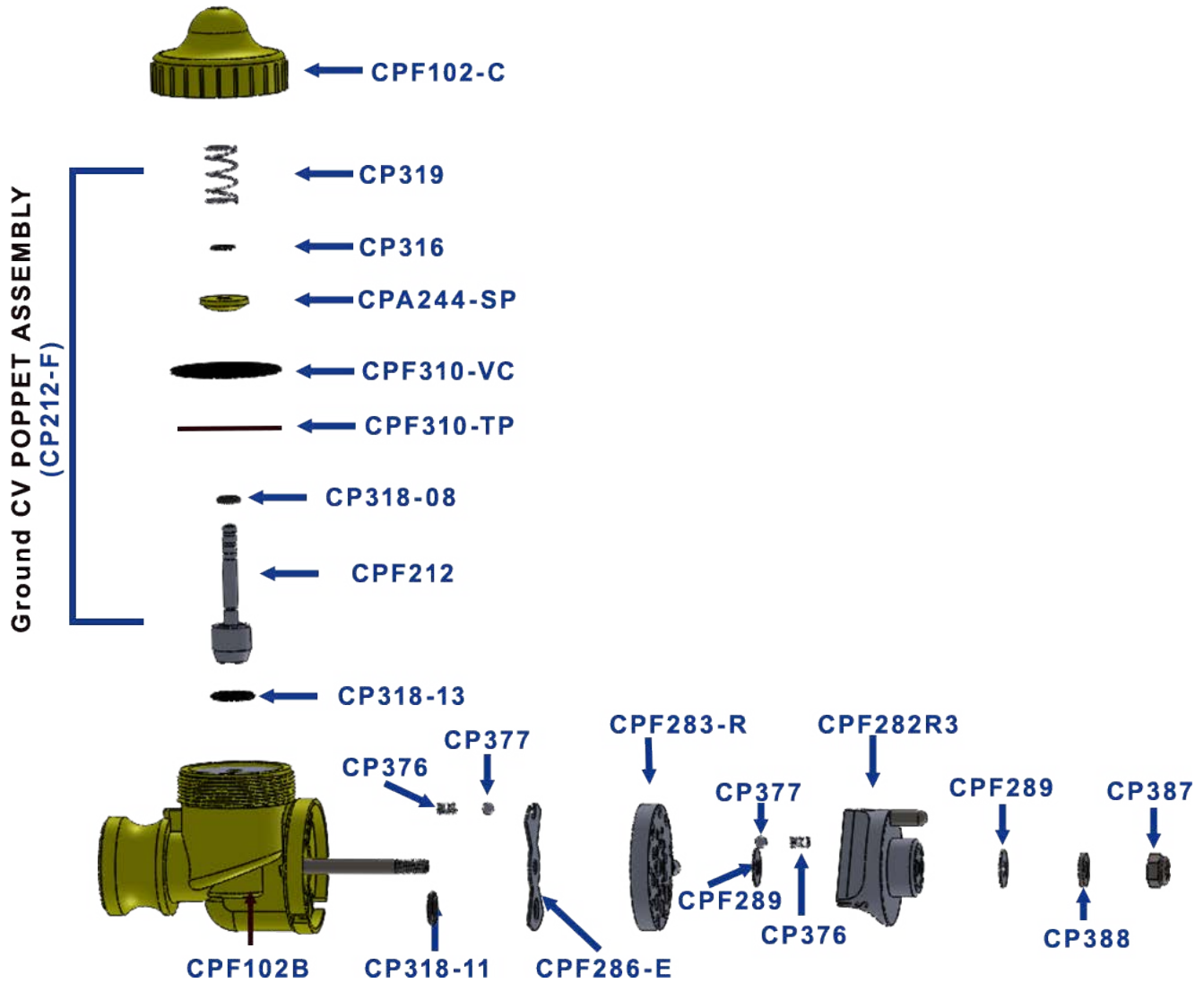

## Long-Term Cost Savings

Initial Cost  
for CP Setup



- \$ Variety of Use of Nozzle Settings
- \$ Versatility of Spray Pattern
- \$ Durability of Nozzels
- \$ Interchangeable Parts
- \$ Less Downtime



The initial cost of CP Nozzles saves money over time because they are long-lasting — made to withstand wear, pressure, and various applications. In addition, if wear or damage occurs, reasonably priced replacement parts are available.

## Time Savings

**Other Brand's  
Install Time**

**CP Products  
Install Time**

More Downtime = Less Profit    Less Downtime = More Profit



CP's make it easy to change rates and droplet sizes in the field, all within minutes. The orifices and deflectors allow applicators the ability to dial in the flow rate and droplet sizes needed. This results in saving time and money.



# Sprayer Turbo Nozzles (Post Emerge)

CP's patented sprayer turbo nozzle for post-emerge sprayers has multiple orifices and tips in high-quality, compact units. Standard quarter-turn quick change bodies can be adapted to new and existing sprayers without tools. These CPs are designed for self-propelled and tractor-mounted sprayers. They produce a tight spectrum of large droplets with few driftable fines. Any deflector tip can be used with any orifice. All versions have flat fan flow rates. All sprayer parts are replaceable. Use the CP Quick Calc to find suggested settings for nozzles.

## CP-65T-SL Low Volume Sprayer Turbo Nozzle

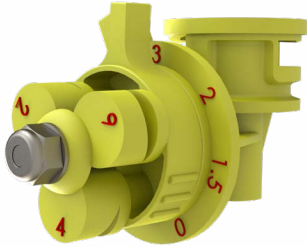

- GPM range of .13 to .67
- Glass-filled nylon standard quarter-turn quick change body
- Poly Six Orifice Selector with Flat Fan Flow Rates: 1.5, 2, 3, 4, 5, 6
- Poly Deflector Tips: 2, 4, and 6. Any deflector tip can be used with any orifice.
- Mounting is recommended for 20" centers or less. Orientation should be between 0° and 45° upward of ground parallel.
- Operating pressures are between 30 to 50 psi

## CP-65T-S Standard Sprayer Turbo Nozzle

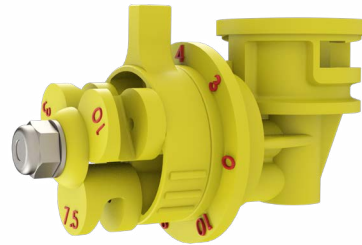

- GPM range of .26 to 1.12
- Glass-filled nylon standard quarter-turn quick change body
- Poly Six Orifice Selector with Flat Fan Flow Rates: 3, 4, 5, 6, 8, 10
- Poly Deflector Tips: 3, 7.5, and 10. Any deflector tip can be used with any orifice.
- Mounting is recommended for 30" centers or less. Orientation should be between 0° and 45° upward of ground parallel
- Operating pressures are between 30 to 50 psi

## CP-65T-SHP High Volume Sprayer Turbo Nozzle

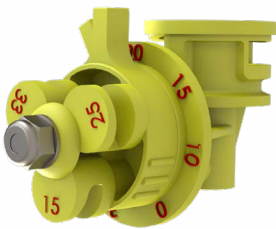

- GPM range of .87 to 3.69
- Glass-filled nylon standard quarter-turn quick change body
- Poly Six Orifice Selector with Flat Fan Flow Rates: 10, 15, 20, 25, 30, 33
- Poly Deflector Tips: 15, 25, and 33. Any deflector tip can be used with any orifice
- Mounting is recommended for 40" centers or less. Orientation should be between 0° and 45° upward of ground parallel
- Operating pressures are between 30 to 50 psi

## CP-74C Four Tip Carousel Cam Lock

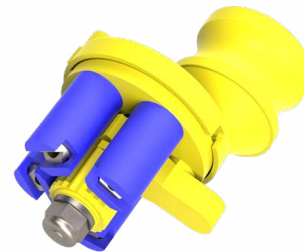

- 3/4" Male Cam lock
- 4 Tip carousel sprayer nozzle
- Tips installed are customer choice
- See tip charts on pages 26 and 27 for flow rates and tip options



The CP-65T-S nozzle was used to spray glyphosate on this field.



### CP-74Q Four Tip Carousel Quick Disconnect

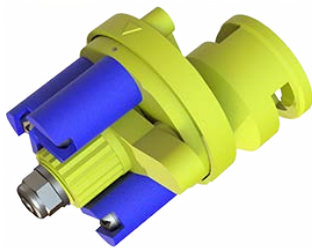

- 1/4 Turn quick disconnect
- 4 Tip carousel sprayer nozzle
- Tips installed are customer choice
- See tip charts on pages 25 and 26 for flow rates and tip options



**CP-65T-SL3 Low Volume Turbo Sprayer Nozzle with Triple Stream Tip**

### CP's Triple Stream Accessory Tip for CP's Sprayer Turbo Nozzles (CP-65T-S3, CP-65T-SL3, and CP-65T-SHP3)

This accessory tip is ideal for fertilizer applications and fits all three volume versions of CP's Sprayer Turbo nozzles. Customers can order these nozzles with the triple streamer tip pre-installed. Designed for 20" spacing, the tip at 14 mph/40 psi yields rates as low as 3.2 gpa to as high as 23.3 gpa. The gpa depends upon which volume nozzle and orifice is being used.

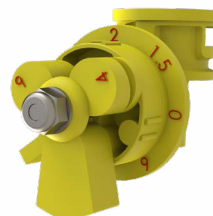

- GPM range with Triple Stream tip is .13 to .96 @ 30-60 psi
- 1/4 Turn quick disconnect

### CP-65T-S3 Medium Volume Turbo Sprayer Nozzle with Triple Stream Tip

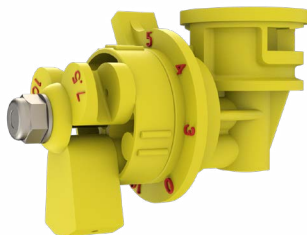

- GPM range with Triple Stream tip is .19 to 1.35 @30-60 psi
- 1/4 Turn quick disconnect

### CP-65T-SHP3 High Volume Turbo Sprayer Nozzle with Triple Stream Tip

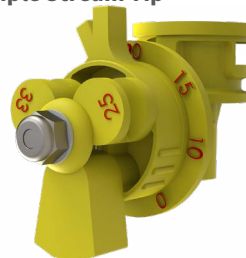

- GPM range with Triple Stream tip is .84 to 1.19 @ 30-60 psi
- 1/4 Turn quick disconnect

The simplicity of the Sprayer Turbo nozzle design, ease of installation, reasonable prices, and parts availability make it an economical alternative to more expensive, maintenance-intensive boom systems.

- Easily adaptable to new and existing sprayers without tools, wiring, or electronics
- Provides (in a single setting) selectable flow rates and droplet sizes, which typically require at least six different hydraulic nozzles
- Flow rates can range from 0.26 to 1.28 GPM at pressures ranging from 30 to 60 psi
- The wide range in droplet sizes allows the flexibility to select droplet sizes to minimize spray drift near sensitive areas, yet permits appropriate selection of droplet sizes for coverage-sensitive crop protection products
- Uniformity of spectrum droplet sizes makes a high percentage of droplets available for dosage transfer, with minimal evaporation of small droplets and minimal spray volume in extremely large droplets that are less effective
- Ease of prescriptively applying large droplets extends conditions under which safe spray applications can be made

# CP-65T-SL — Replacement Parts

Low Volume Sprayer Turbo

Poly Tips 2, 4, & 6

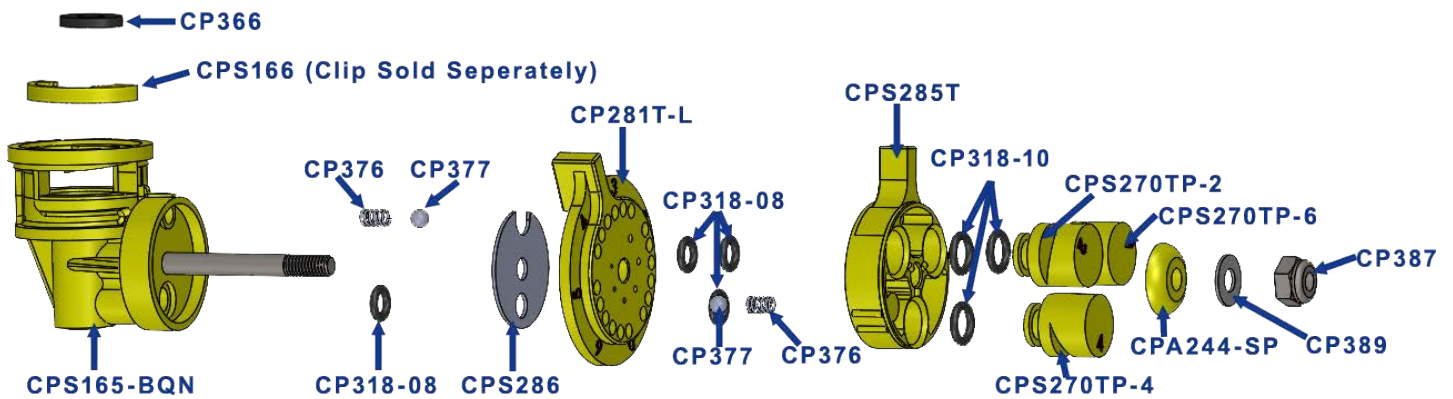

# CP-65T-S — Replacement Parts

Medium Volume Sprayer Turbo

Poly Tips 3, 7.5, & 10

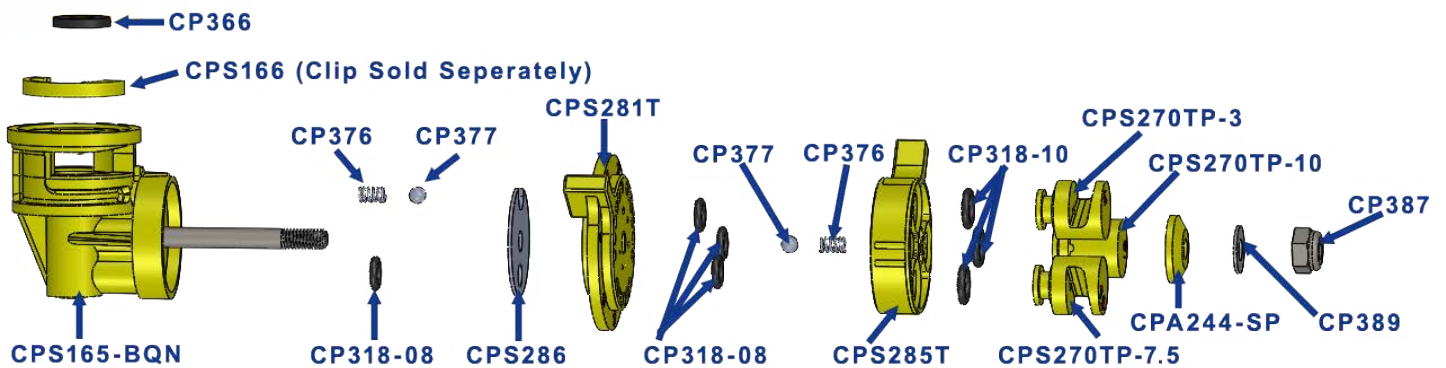

# CP-65T-SHP — Replacement Parts

High Volume Sprayer Turbo

Poly Tips 15, 25, & 33

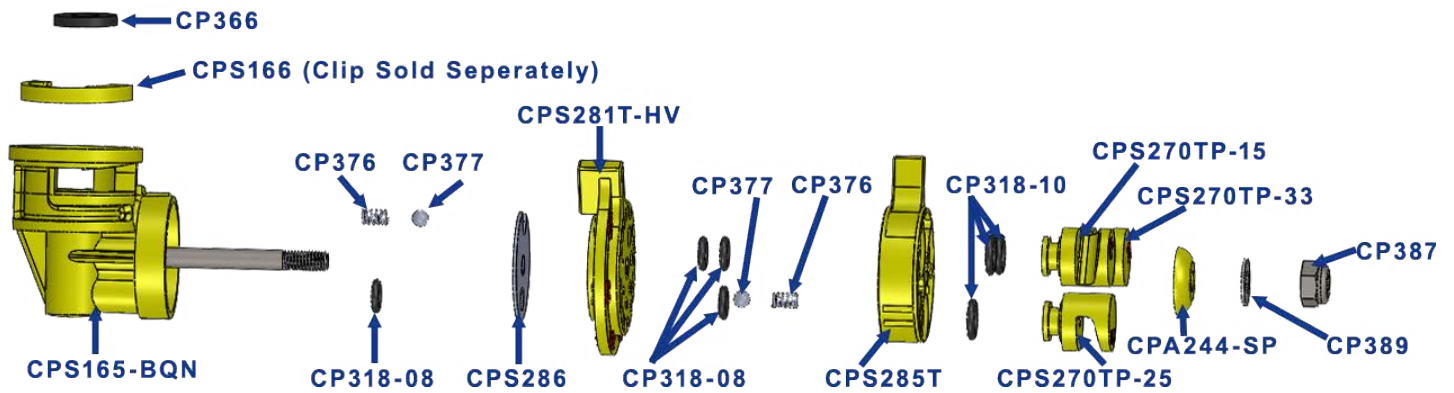

## CP Adaptor for Certified Tips



Take any quarter-turn certified tip and mount it onto the CP-65T-SL, CP-65T-S or CP-65T-SHP nozzle body.

*This process takes less than a minute! See page 24 for details.*

# CP-74C — Replacement Parts

Four Tip Carousel

See pages 26-27 for Tip Options

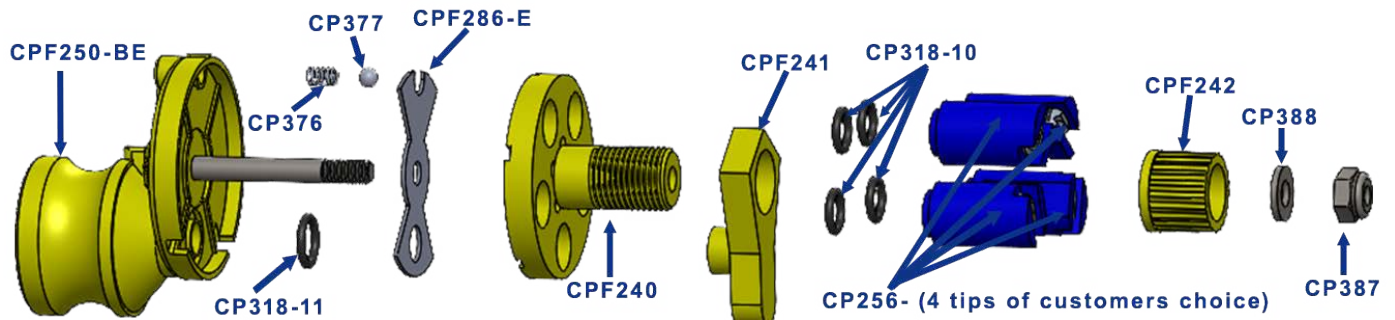

\* CPF243 POLY 4 Tip Carousel Hand Wrench is also available for purchase.

# CP-74Q — Replacement Parts

Four Tip Carousel

See pages 26-27 for Tip Options

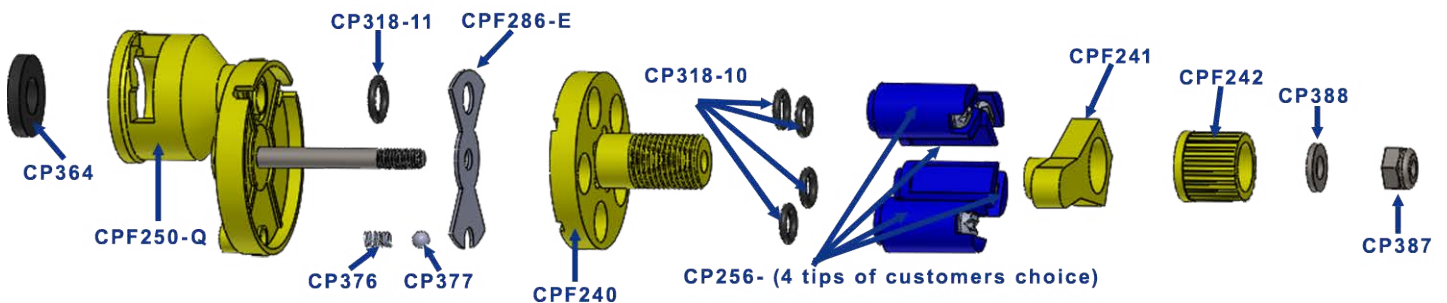

\* CPF243 POLY 4 Tip Carousel Hand Wrench is also available for purchase.





Made With Quality Materials

Application Products = CP Products

- ☑ Durability
- ☑ Toughness
- ☑ Strength

Transland uses superior materials to create durable products that withstand the use of different products over multiple seasons.



Customer Service

Customer Service =

- CP Quick Calculator
- Free Resources
- Trouble Shooting Problems
- Transland Engineer Support
- Direct Line for Dealers

Transland offers tools to help the applicator be efficient and profitable. It also supports its dealers and customers if a customer has a problem.

# Check Valves

CP check valves provide high flow capacity with instant shut-off. Made with glass-filled polypropylene material with a stainless steel core, these check valves are durable and long-lasting. Low maintenance, quick pull needle stem removes any caught debris without needing to open up the check valve. All parts are replaceable.

## CP-110C 3/4" Cam Lock Inlet Check Valve



- Glass-Filled Polypropylene Body with Stainless Steel Core
- 3/4" Male Cam Lock Inlet
- 3/4" Female Cam Lock Outlet
- Flow Rate of 12.1 GPM at 40 psi
- Standard Stainless Steel 9lb Spring
- Available with a Heavy Duty 11lb Spring as a CP110-C-HD

## CP-110P 3/4" Pipe Inlet Check Valve



- Glass-Filled Polypropylene Body with Stainless Steel Core
- 3/4" Male Threaded Inlet
- 3/4" Female Cam Lock Outlet
- Flow Rate of 12.1 GPM at 40 psi
- Standard Stainless Steel 9lb Spring
- Available with a Heavy Duty 11lb Spring as a CP110-P-HD

## CP-112SE 1" Split Eye Check Valve for 1" Pipe

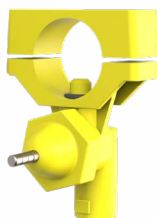

- Glass-Filled Nylon Body with Stainless Steel Core
- 1" Split Eyelet Inlet
- Quick Coupler Outlet
- Flow Rate of 5.2 GPM at 40 psi
- Standard Stainless Steel 9lb Spring
- A lighter 4lb spring comes with part for lower pressures

## CP-112SE 3/4" Split Eye Check Valve for 3/4" Pipe

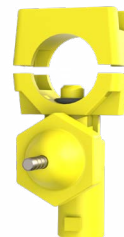

- Glass-Filled Nylon Body with Stainless Steel Core
- 3/4" Split Eyelet Inlet
- Quick Coupler Outlet
- Flow Rate of 5.2 GPM at 40 psi
- Standard Stainless Steel 9lb Spring
- A lighter 4lb spring comes with part for lower pressures

- Easy to install
- The glass filled Nylon or Poly body with stainless steel core make these check valves durable and long lasting
- Low maintenance, quick pull needle stem easily removes any caught debris without opening up check valve

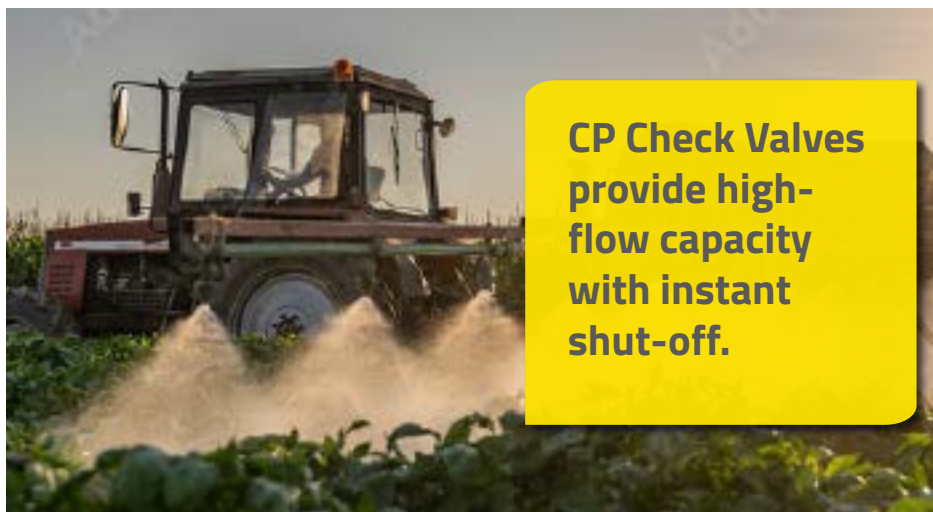

**CP Check Valves provide high-flow capacity with instant shut-off.**



The CP Air Stop air-actuated valves have a faster positive shut-off than traditional pinch valves. These valves have a standard Viton-type diaphragm and Xtreme Duty 23 lb spring, creating high flow capacity with an instant shut-off. The body is made with glass-filled polypropylene material with a stainless steel core; these check valves are durable and long-lasting. CP Air Stop Check Valve can be used in boom section shut-off or to attach nozzles with 3/4" cam lock inlets like the CP-59LS/HV or CP-55R3.

#### CP-110C-AS 3/4" Cam Inlet Air Stop Check Valve



- Glass-filled Polypropylene Body with Stainless Steel Core
- 3/4" Male Cam Lock Inlet
- 3/4" Female Cam Lock Outlet
- Flow Rate of 12.1 GPM at 40 psi
- Designed for high or low volume spraying
- Air shut-off and check valve combine
- Air Stop available for Camlock or Pipe thread inputs

#### CP-110P-AS 3/4" Pipe Inlet Air Stop Check Valve

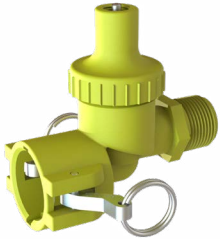

- Glass-filled Polypropylene Body with Stainless Steel Core
- 3/4" Male Pipe Thread Inlet
- 3/4" Female Cam Lock Outlet
- Flow Rate of 12.1 GPM at 40 psi
- Designed for high or low volume spraying
- Air shut-off and check valve combine
- Air Stop available for Camlock or Pipe thread inputs

### Compare Air Stop to Pinch Valves

- Faster shut-off
- Easy maintenance design that can be done in the field if needed, no tools required (all this keeps workflow going)
- Longer lasting
- Operates at lower air volume, saving wear and tear on compressor (between 20-40 psi higher liquid pressure)
- All-In-One design requires fewer fittings to connect to boom, reducing bulk and possible loss of nozzle

## Benefits of Air Stop with CP Turbo Floater Nozzles

- Requires less fittings to connect to boom, reducing bulk and possible loss of nozzle
- **FAST SHUT-OFF!** Complete shut-off within seconds, resulting in **NO leaks and NO drips**
- Operating air pressure falls between 20-40 psi higher than liquid pressure
- Operating at lower air volume, reduces the wear and tear on compressor
- Low Volume Nozzle GPM ranges of .43 to 6.71 (depending upon nozzle combo used)
- High Volume Nozzle GPM ranges of .87 to 13.42 (depending upon nozzle combo used)
- Can be used with 30", 40" and 60" spacing
- Simple conversion kits are available for those already using other CP nozzles
- Because of design, maintenance can be done in the field with no tools required, thus keeping work flow going

# CP-110C & CP-110P – Replacement Parts

3/4" Cam Lock & Pipe Check Valves

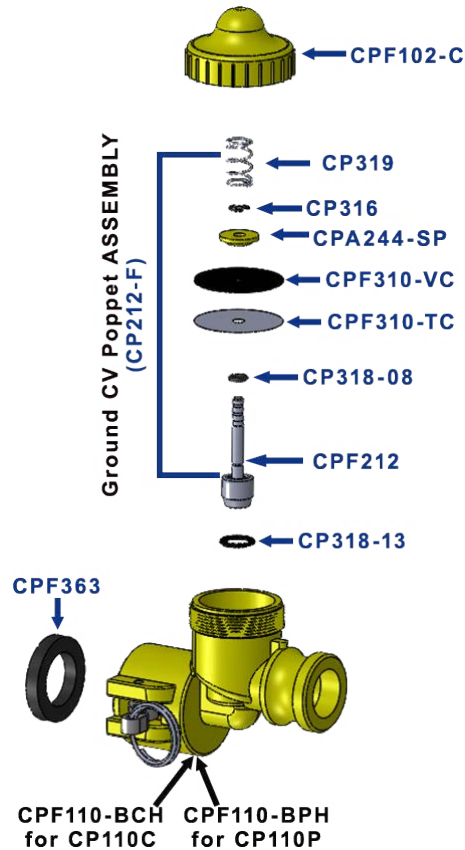

# CP-112SE 3/4" & CP-112SE 1" – Replacement Parts

3/4" & 1" Split Eye Check Valves

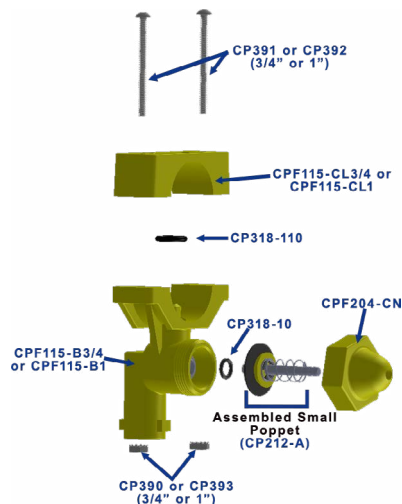



# CP-110C-AS & CP-110P-AS — Replacement Parts

3/4" Cam Lock & Pipe Air Stop Check Valves

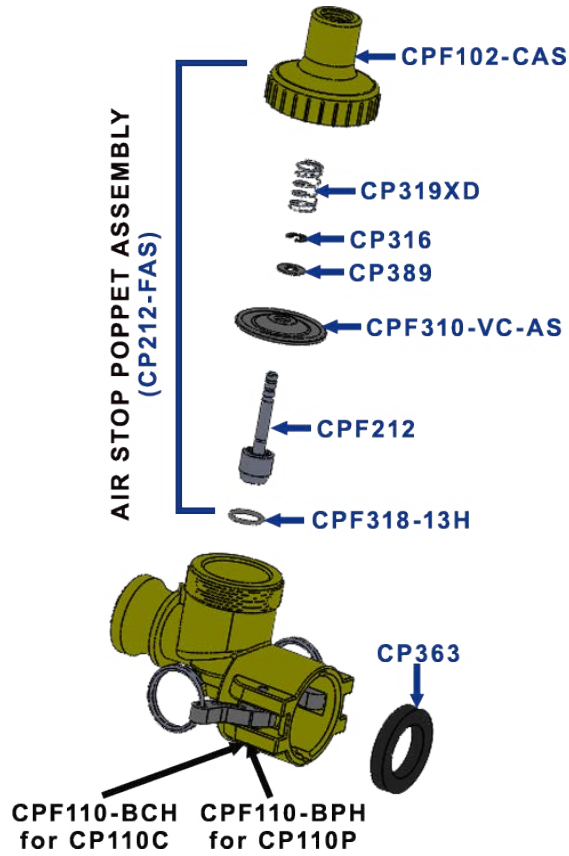

# Spray Accessories

CP offers a variety of spray accessories to change nozzle angle or clean up connection surface. Angles come in 90° or 45°. Accessories are available in cam lock or threaded and 3/4" pipe or 1" pipe.

## CP-80C 3/4" Cam Lock 90° Elbow



- Glass-Filled Polypropylene Body
- 3/4" Male Cam Lock Inlet
- 3/4" Female Cam Lock Outlet
- 3/4" EPDM Gasket
- 90° Elbow

## CP-80P 3/4" Threaded Male Pipe 90° Elbow



- Glass-Filled Polypropylene Body
- 3/4" Threaded Male Pipe Inlet
- 3/4" Female Cam Lock Outlet
- 3/4" EPDM Gasket
- 90° Elbow

## CP-80P1 1" Threaded Male Pipe 90° Elbow



- Glass-Filled Polypropylene Body
- 1" Threaded Male Pipe Inlet
- 3/4" Female Cam Lock Outlet
- 3/4" EPDM Gasket
- 90° Elbow

## CP-81C 3/4" Cam Lock 45° Elbow



- Glass-Filled Polypropylene Body
- 3/4" Male Cam Lock Inlet
- 3/4" Female Cam Lock Outlet
- 3/4" EPDM Gasket
- 45° Elbow

### CP-81P 3/4" Threaded Male Pipe 45° Elbow



- Glass-Filled Polypropylene Body
- 3/4" Threaded Male Pipe Inlet
- 3/4" Female Cam Lock Outlet
- 3/4" EPDM Gasket
- 45° Elbow

### CP-81P1 1" Threaded Male Pipe 45° Elbow



- Glass-Filled Polypropylene Body
- 1" Threaded Male Pipe Inlet
- 3/4" Female Cam Lock Outlet
- 3/4" EPDM Gasket
- 45° Elbow

### CP-49 Poly Filter Screen



- 50 mesh stainless steel screen
- Fits 3/4" male threaded and cam lock connections
- Captures any debris before it clogs nozzle orifice
- Easy to remove and clean

### CPS2751 Adaptor



- Mount any quarter-turn certified tip onto a CP® Sprayer Turbo nozzle CP-65T-SL, CP-65T-S, or CP-65T-SHP nozzle body
- To adjust for flow rate, turn the selector dial to the largest orifice, and the flow is controlled by the tip attached to the adaptor.
- Process takes less than a minute
- *Note: The maximum flow rate of the tip cannot be greater than the largest flow rate of the CP orifice. Install is fast and easy; replace one of the poly tips with the adaptor and tighten the nut.*

### CPF2751 Adaptor



- Mount any quarter-turn certified tip onto a CP® Floater Turbo nozzle CP-59LS, CP-59HV, CP-109LS, or CP-109HV nozzle body
- To adjust for flow rate, turn the selector dial to the largest orifice, and the flow is controlled by the tip attached to the adaptor.
- Process takes less than a minute
- *Note: The maximum flow rate of the tip cannot be greater than the largest flow rate of the CP orifice. Install is fast and easy; replace one of the poly tips with the adaptor and tighten the nut.*

# Tip Options

## CPS275T-3SS1 Turbo Floater Tip - Triple Stream Tip



Ideal for liquid fertilizer applications, this accessory tip fits all three volume versions of the CP Sprayer Turbo Nozzles (CP-65 nozzle series). Designed for 20" spacing, the Triple Stream Tip at 14 mph/40 psi will turn out rates as low 3.2 gpa to as high as 23.3 gpa. These numbers depend upon which volume nozzle is used.

- 3 fully defined clean streams with equal capacity and velocity
- 3-Stream pattern reduces leaf burn and drift
- Ease of interchangeable tips
- Durable construction — impact resistant, UV resistant, and highly wear resistant
- Good chemical resistance
- Boom Spacing: 20"
- Flow Rate: .12 to 1.35 gpm, depending upon volume version
- Operating Speed: 10 to 20 mph
- 30-60 psi

**Only works with CP-65T-SL, CP-65T-S, AND CP-65T-SHP**

## CPF270T-5ST1 Turbo Floater Tip - 5 Stream Tip



Ideal for liquid fertilizer applications, this accessory tip fits low and high volume versions of the CP Floater Turbo nozzles (CP-59s and CP-109s series). This five-stream tip is excellent for directed liquid application on bare ground or in standing crop.

- 5 fully defined clean streams with equal capacity and velocity
- 5-Stream pattern reduces leaf burn and drift
- Ease of interchangeable tips
- Durable construction — impact resistant, UV resistant, and highly wear resistant
- Good chemical resistance
- Boom Spacing: 30", 40", 60"
- Flow Rate: 4 to 77 gpm
- Operating Speed: 10-20 mph
- Pressure Range: 30-50 psi

**Only works with CP-59LS, CP-59HV, CP-109LS and CP-109HV**

## CP-59LS, CP-59HV, CP-109LS and CP-109HV — Tip Options

Part #	Description
CPF270T-5	Floater Turbo Tip – 5
CPF270T-7.5	Floater Turbo Tip – 7.5
CPF270T-10	Floater Turbo Tip – 10
CPF270T-12	Floater Turbo Tip – 12
CPF270T-15	Floater Turbo Tip – 15
CPF270T-18	Floater Turbo Tip – 18
CPF270T-30	Floater Turbo Tip – 30
CPF270T-35	Floater Turbo Tip – 35
CPF270T-60	Floater Turbo Tip – 60
CPF270T-60HV	Floater Turbo Tip – 60HV



## CP-74C and CP-74Q – Tip Options

### Straight Stream Tip

Part #	PSI	GPM
CP256-0006	30	.52
	40	.60
	50	.67
CP256-0008	30	.69
	40	.80
	50	.89
CP256-0010	30	.87
	40	1.0
	50	1.18
CP256-0012	30	1.04
	40	1.20
	50	1.42
CP256-0015	30	1.30
	40	1.50
	50	1.68
CP256-0020	30	1.73
	40	2.0
	50	2.24
CP256-0025	30	2.17
	40	2.50
	50	2.95

### 20° Flat Fan Tips

Part #	PSI	GPM
CP256-2004	30	.35
	40	.40
	50	.45
CP256-2006	30	.52
	40	.60
	50	.67
CP256-2008	30	.69
	40	.80
	50	.89
CP256-2010	30	.87
	40	1.00
	50	1.18
CP256-2012	30	1.04
	40	1.20
	50	1.42
CP256-2015	30	1.30
	40	1.50
	50	1.68
CP256-2020	30	1.73
	40	2.00
	50	2.24

### 40° Flat Fan Tips

Part #	PSI	GPM
CP256-4004	30	.35
	40	.40
	50	.45
CP256-4006	30	.52
	40	.60
	50	.67
CP256-4008	30	.69
	40	.80
	50	.89
CP256-4010	30	.87
	40	1.00
	50	1.18
CP256-4012	30	1.04
	40	1.20
	50	1.42
CP256-4015	30	1.30
	40	1.50
	50	1.68
CP256-4020	30	1.73
	40	2.00
	50	2.24
CP256-4025	30	2.17
	40	2.50
	50	2.95
CP256-4030	30	2.60
	40	3.00
	50	3.54

## CP-74C and CP-74Q – Tip Options (Continued)

### 80° Flat Fan Tips

Part #	PSI	GPM
CP256-8002	30	.17
	40	.20
	50	.22
CP256-8003	30	.26
	40	.30
	50	.34
CP256-8004	30	.35
	40	.40
	50	.45
CP256-8005	30	.43
	40	.50
	50	.56
CP256-8006	30	.52
	40	.60
	50	.67
CP256-8008	30	.69
	40	.80
	50	.89
CP256-8010	30	.87
	40	1.00
	50	1.18
CP256-8012	30	1.04
	40	1.20
	50	1.42
CP256-8015	30	1.30
	40	1.50
	50	1.68
CP256-8020	30	1.73
	40	2.00
	50	2.24
CP256-8025	30	2.17
	40	2.50
	50	2.95
CP256-8030	30	2.60
	40	3.00
	50	3.54

### 110° Flat Fan Tips

Part #	PSI	GPM
CP256-110-4	30	.35
	40	.40
	50	.45
CP256-110-6	30	.52
	40	.60
	50	.67
CP256-110-8	30	.69
	40	.80
	50	.89

# Technical Data & Reference Charts

CP offers Gallon Per Acre, Gallons Per Minute and Spray Classification charts for all its nozzles. Droplet spectrum, or spray quality, is a crucial component of successful applications. Droplets that are too small may not reach the target and may drift. Droplets that are too large may not give adequate coverage; however, ALWAYS follow the product label for proper droplet size and efficacy. Below are useful formulas for Spray Nozzle GPM (Gallons Per Minute) & GPA (Gallons Per Acre).

$$\text{GPM: Gallons Per Minute} \quad \text{GPM} = \frac{\text{GPA} \times \text{mph} \times \text{W}}{5,940} \quad \text{GPA} = \frac{5,940 \times \text{GPM (Per Nozzle)}}{\text{mph} \times \text{W}}$$

GPA: Gallons Per Acre

MPH: Miles Per Hour

- W: Nozzle spacing (in inches) for broadcast spraying
- Spray width (in inches) for single nozzle, band spraying or boomless spraying.
  - Row spacing (in inches) divided by the number of nozzles per row for directed spraying.

Check the appropriate chart for flow rates of nozzle that is being used. Determine desired GPM, appropriate orifice/deflector, pressure, and speed for product label requirements and climatic conditions. Adjust orifice and deflector, pressure and boom height to give 100% overlaps at the target — either ground or crop canopy. **The CP Quick Calculator is a free tool for choosing which products and setups will work the best for the different jobs.** Below are some quick reference tables.

## Weights & Measures Conversions

### Weight

- 16 ounces = 1 pound = 453.6 grams
- 1 gallon water = 8.34 pounds = 3.78 liters

### Liquid Measure

- 1 fluid ounce = 2 tablespoons = 29.57 milliliters
- 16 fluid ounces = 1 pint = 2 cups
- 8 pints = 4 quarts = 1 gallon
- 1 gallon = 128 fl oz = 8 pints = 4 quarts = 3.79 liters = 0.83 imperial gallon

### Length

- 3 feet = 1 yard = 91.44 centimeters
- 16.5 feet = 1 rod
- 5280 feet = 1 mile = 1.61 kilometers = 1610 m
- 320 rods = 1 mile

### Area

- 9 square feet = 1 square yard
- 43,560 square feet = 1 acre = 160 square rods
- 1 acre = 0.405 hectare
- 1 hectare = 2.471 Acres
- 640 acres = 1 square mile

### Speed

- 88 feet per minute = 1 mph
- 1 mph = 1.61 kilometers per hour

### Volume

- 27 cubic feet = 1 cubic yard
- 1 cubic foot = 1728 cubic inches = 7.48 gallons
- 1 gallon = 231 cubic inches
- 1 cubic foot = 0.028 cubic meters

### Pressure

- 1 psi = 0.069 bar = 6.896 kilopascals

## Tractor Speeds

Speed in MPH	Time Required in Seconds to Travel		
	100 ft	200 ft	300 ft.
1.0	68	136	205
1.5	45	91	136
2.0	34	68	102
2.5	27	55	82
3.0	23	45	68
3.5	20	39	58
4.0	17	34	51
4.5	15	30	45
5.0	14	27	41
5.5		25	37
6.0	11	23	34
6.5		21	31
7.0	9.7	19	29
7.5	9	18	27
8.0	8.5	17	26
8.5		16	24
9.0	7.6	15	23
10	6.8	13.6	20.5

# Droplet Classification Information

- **Droplet sizes are measured in microns.** One-hundred (100) microns is about the diameter of a human hair.
- **VMD** is the size, in microns, of the drop marking the middle of the drop-let sizes in the spray volume. Half the spray volume is in droplets larger than the VMD and half the volume is in smaller droplets. VMD is not an average of the droplets in the spray volume.
- **Spray Classification** refers to ASABE S572.1 Standard. categories of droplet spectra.

Spray Classifications	Approximate VMD
Very Fine (VF)	Less than 105 $\mu$
Fine (F)	106-235
Medium (M)	236-340
Coarse (C)	341-403
Very Coarse (VC)	404-502
Extremely Coarse (XC)	503-665
Ultra Coarse (UC)	Over 665 $\mu$

- **Relative Span** is a ratio indicating the evenness of droplet sizes in the middle 80% of the spray volume. The smaller the number, the more even the spray volume.

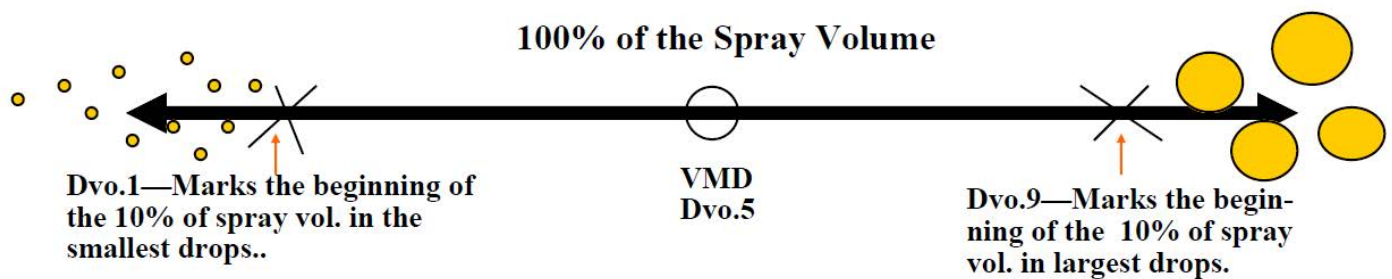

- **Relative span is the most important indicator of spray quality.** It is calculated as follows:

If Dvo.9 (as measured in laboratory tests) is 400 microns, Dvo.5 is 300 and Dvo.1 is 100, the relative span would be 1, a good number (Dvo.9 mi-nus Dvo.1 divided by Dvo.5, the VMD). If the large number is 900 and the small one 150 with a VMD of 300, the RS would be 2.5—a much more uneven spray.

- These terms will appear, in one form or another, on pesticide labels.



# GPA Chart: CP-74Q and CP-74C

## Four Tip Carousel Quick Disconnect

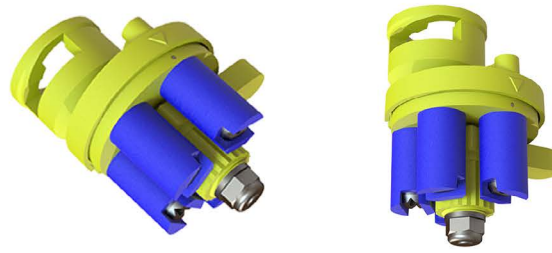

CP-74Q Carousel			Gallons Per Acre														
Tip	PSI	Nozzle Capacity GPM	15" Spacing					20" Spacing					30" Spacing				
			10 MPH	12 MPH	14 MPH	16 MPH	18 MPH	10 MPH	12 MPH	14 MPH	16 MPH	18 MPH	10 MPH	12 MPH	14 MPH	16 MPH	18 MPH
8002	30	0.17	6.73	5.61	4.81	4.21	3.74	5.05	4.21	3.61	3.16	2.81	3.37	2.81	2.40	2.10	1.87
	40	0.2	7.92	6.60	5.66	4.95	4.40	5.94	4.95	4.24	3.71	3.30	3.96	3.30	2.83	2.48	2.20
	50	0.22	8.71	7.26	6.22	5.45	4.84	6.63	5.45	4.67	4.08	3.63	4.36	3.63	3.11	2.72	2.42
	60	0.24	9.50	7.92	6.79	5.94	5.28	7.13	5.94	5.09	4.46	3.96	4.75	3.96	3.39	2.97	2.64
8003	30	0.26	10.30	8.58	7.35	6.44	5.72	7.72	6.44	5.52	4.83	4.29	5.15	4.29	3.68	3.22	2.86
	40	0.3	11.88	9.90	8.49	7.43	6.60	8.91	7.43	6.36	5.57	4.95	5.94	4.95	4.24	3.71	3.30
	50	0.34	13.46	11.22	9.62	8.42	7.48	10.10	8.42	7.21	6.31	5.61	6.73	5.61	4.81	4.21	3.74
	60	0.37	14.65	12.21	10.47	9.16	8.14	10.99	9.16	7.85	6.87	6.11	7.33	6.11	5.23	4.58	4.07
2004	30	0.35	13.86	11.55	9.90	8.66	7.70	10.40	8.66	7.43	6.50	5.78	6.93	5.78	4.95	4.33	3.85
4004	40	0.4	15.84	13.20	11.31	9.90	8.80	11.88	9.90	8.49	7.43	6.60	7.92	6.60	5.66	4.95	4.40
8004	50	0.45	17.82	14.85	12.73	11.14	9.90	13.37	11.14	9.55	8.35	7.43	8.91	7.43	6.36	5.67	4.95
110-4	60	0.49	19.40	16.17	13.86	12.13	10.78	14.55	12.13	10.40	9.10	8.09	9.70	8.09	6.93	6.06	5.39
8005	30	0.43	17.03	14.19	12.16	10.64	9.46	12.77	10.64	9.12	7.98	7.10	8.51	7.10	6.08	5.32	4.73
	40	0.5	19.80	16.50	14.14	12.38	11.00	14.85	12.38	10.61	9.28	8.25	9.90	8.25	7.07	6.19	5.50
	50	0.56	22.18	18.48	15.84	13.86	12.32	16.63	13.86	11.88	10.40	9.24	11.09	9.24	7.92	6.93	6.16
	60	0.61	24.16	20.13	17.25	15.10	13.42	18.12	15.10	12.94	11.32	10.07	12.08	10.07	8.63	7.55	6.71
0006	30	0.52	20.59	17.16	14.71	12.87	11.44	15.44	12.87	11.03	9.65	8.58	10.30	8.58	7.35	6.44	5.72
2006	40	0.6	23.76	19.80	16.97	14.85	13.20	17.82	14.85	12.73	11.14	9.90	11.88	9.90	8.49	7.43	6.60
4006	50	0.67	26.53	22.11	18.95	16.58	14.74	19.90	16.58	14.21	12.44	11.06	13.27	11.06	9.48	8.29	7.37
8006	60	0.73	28.91	24.09	20.65	18.07	16.06	21.68	18.07	15.49	13.55	12.05	14.45	12.05	10.32	9.03	8.03
0008	30	0.69	27.32	22.77	19.52	17.08	15.18	20.49	17.08	14.64	12.81	11.39	13.66	11.39	9.76	8.54	7.59
2008	40	0.8	31.68	26.40	22.63	19.80	17.60	23.76	19.80	16.97	14.85	13.20	15.84	13.20	11.31	9.90	8.80
4008	50	0.89	35.24	29.37	25.17	22.03	19.58	26.43	22.03	18.88	16.52	14.69	17.62	14.69	12.59	11.01	9.79
8008	60	0.98	38.81	32.34	27.72	24.26	21.56	29.11	24.26	20.79	18.19	16.17	19.40	16.17	13.86	12.13	10.78
110-8	60	0.98	38.81	32.34	27.72	24.26	21.56	29.11	24.26	20.79	18.19	16.17	19.40	16.17	13.86	12.13	10.78
0010	30	0.87	34.45	28.71	24.61	21.53	19.14	25.84	21.53	18.46	16.15	14.36	17.23	14.36	12.30	10.77	9.57
2010	40	1	39.60	33.00	28.29	24.75	22.00	29.70	24.75	21.21	18.66	16.50	19.80	16.50	14.14	12.38	11.00
4010	50	1.18	46.73	38.94	33.38	29.21	25.96	35.05	29.21	25.03	21.90	19.47	23.36	19.47	16.69	14.60	12.98
8010	60	1.23	48.71	40.59	34.79	30.44	27.06	36.53	30.44	26.09	22.83	20.30	24.35	20.30	17.40	15.22	13.53
0012	30	1.04	41.18	34.32	29.42	25.74	22.88	30.89	25.74	22.06	19.31	17.16	20.59	17.16	14.71	12.87	11.44
2012	40	1.2	47.52	39.60	33.94	29.70	26.40	35.64	29.70	25.46	22.28	19.80	23.76	19.80	16.97	14.85	13.20
4012	50	1.42	56.23	46.86	40.17	35.15	31.24	42.17	35.15	30.12	26.36	23.43	28.12	23.43	20.08	17.57	15.62
8012	60	1.47	58.21	48.51	41.58	36.38	32.34	43.66	36.38	31.19	27.29	24.26	29.11	24.26	20.79	18.19	16.17
0015	30	1.3	51.48	42.90	36.77	32.18	28.60	38.61	32.18	27.58	24.13	21.45	25.74	21.45	18.39	16.09	14.30
2015	40	1.5	59.40	49.50	42.43	37.13	33.00	44.55	37.13	31.82	27.84	24.75	29.70	24.75	21.21	18.56	16.60
4015	50	1.68	66.53	55.44	47.52	41.58	36.96	49.90	41.58	35.64	31.19	27.72	33.26	27.72	23.76	20.79	18.48
8015	60	1.84	72.86	60.72	52.05	45.54	40.48	54.65	45.54	39.03	34.16	30.36	36.43	30.36	26.02	22.77	20.24
0020	30	1.73	68.51	57.09	48.93	42.82	38.06	51.38	42.82	36.70	32.11	28.55	34.25	28.55	24.47	21.41	19.03
2020	40	2	79.20	66.00	56.57	49.50	44.00	59.40	49.50	42.43	37.13	33.00	39.60	33.00	28.29	24.75	22.00
4020	50	2.24	88.70	73.92	63.36	55.44	49.28	66.53	55.44	47.52	41.58	36.96	44.35	36.96	31.68	27.72	24.64
8020	60	2.45	97.02	80.85	69.30	60.64	53.90	72.77	60.64	51.98	45.48	40.43	48.51	40.43	34.65	30.32	26.95
0025	30	2.17	85.93	71.61	61.38	53.71	47.74	64.45	53.71	46.04	40.28	36.81	42.97	36.81	30.69	26.85	23.87
4025	40	2.5	99.00	82.50	70.71	61.88	55.00	74.25	61.88	53.04	46.41	41.25	49.50	41.25	35.36	30.94	27.50
8025	50	2.95	116.82	97.36	83.44	73.01	64.90	87.62	73.01	62.58	54.76	48.68	58.41	48.68	41.72	36.51	32.45
60	3.06	121.18	100.98	86.55	75.74	67.32	60.88	90.88	75.74	64.92	56.80	50.49	60.59	50.49	43.28	37.87	33.66
4030	30	2.6	102.96	85.80	73.54	64.35	57.20	77.22	64.35	55.16	48.26	42.90	51.48	42.90	36.77	32.18	28.60
8030	40	3	118.80	99.00	84.86	74.25	66.00	89.10	74.25	63.64	55.69	49.50	59.40	49.50	42.43	37.13	33.00
50	3.54	140.18	116.82	100.13	87.62	77.88	70.88	106.14	87.62	75.10	65.71	58.41	70.09	58.41	50.07	43.81	38.94
60	3.67	145.33	121.11	103.81	90.83	80.74	73.00	109.00	90.83	77.86	68.12	60.56	72.67	60.56	51.90	45.42	40.37
6040	30	3.5	137.02	114.18	97.87	85.64	76.12	102.76	85.64	73.40	64.23	57.09	68.51	57.09	48.93	42.82	38.06
	40	4.0	158.40	132.00	113.14	99.00	88.00	118.80	99.00	84.86	74.25	66.00	79.20	66.00	56.57	49.50	44.00
	50	4.5	177.01	147.51	126.44	110.63	98.34	132.76	110.63	94.83	82.97	73.76	88.51	73.76	63.22	55.32	49.17
	60	4.9	194.04	161.70	138.60	121.28	107.80	145.53	121.28	103.95	90.96	80.85	97.02	80.85	69.30	60.64	53.90

# GPA Chart: CP-55R3 and CP-102R3

## Regular Volume Floater (CP-55R3) and Combo Floater (CP-102R3)



### Gallons Per Acre

Orifice	PSI	GPM	30" Spacing						40" Spacing						60" Spacing					
			6mph	8mph	10mph	14mph	18mph	20mph	6mph	8mph	10mph	14mph	18mph	20mph	6mph	8mph	10mph	14mph	18mph	20mph
5	30	0.87	28.58	21.43	17.15	12.25	9.53	8.57	21.43	16.08	12.86	9.19	7.14	6.43	14.29	10.72	8.57	6.12	4.76	4.29
	40	1.00	33.00	24.75	19.80	14.14	11.00	9.90	24.75	18.56	14.85	10.61	8.25	7.43	16.50	12.38	9.90	7.07	5.50	4.95
	50	1.12	36.90	27.67	22.14	15.81	12.30	11.07	27.67	20.75	16.60	11.86	9.22	8.30	18.45	13.84	11.07	7.91	6.15	5.53
10	30	1.73	57.16	42.87	34.29	24.50	19.05	17.15	42.87	32.15	25.72	18.37	14.29	12.86	28.58	21.43	17.15	12.25	9.53	8.57
	40	2.00	66.00	49.50	39.60	28.29	22.00	19.80	49.50	37.13	29.70	21.21	16.50	14.85	33.00	24.75	19.80	14.14	11.00	9.90
	50	2.24	73.79	55.34	44.27	31.62	24.60	22.14	55.34	41.51	33.21	23.72	18.45	16.60	36.90	27.67	22.14	15.81	12.30	11.07
15	30	2.60	85.74	64.30	51.44	36.74	28.58	25.72	64.30	48.23	38.58	27.56	21.43	19.29	42.87	32.15	25.72	18.37	14.29	12.86
	40	3.00	99.00	74.25	59.40	42.43	33.00	29.70	74.25	55.69	44.55	31.82	24.75	22.28	49.50	37.13	29.70	21.21	16.50	14.85
	50	3.35	110.69	83.01	66.41	47.44	36.90	33.21	83.01	62.26	49.81	35.58	27.67	24.90	55.34	41.51	33.21	23.72	18.45	16.60
20	30	3.46	114.32	85.74	68.59	48.99	38.11	34.29	85.74	64.30	51.44	36.74	28.58	25.72	57.16	42.87	34.29	24.50	19.05	17.15
	40	4.00	132.00	99.00	79.20	56.57	44.00	39.60	99.00	74.25	59.40	42.43	33.00	29.70	66.00	49.50	39.60	28.29	22.00	19.80
	50	4.47	147.58	110.69	88.55	63.25	49.19	44.27	110.69	83.01	66.41	47.44	36.90	33.21	73.79	55.34	44.27	31.62	24.60	22.14
30	30	5.20	171.47	128.60	102.88	73.49	57.16	51.44	128.60	96.45	77.16	55.12	42.87	38.58	85.74	64.30	51.44	36.74	28.58	25.72
	40	6.00	198.00	148.50	118.80	84.86	66.00	59.40	148.50	111.38	89.10	63.64	49.50	44.55	99.00	74.25	59.40	42.43	33.00	29.70
	50	6.71	221.37	166.03	132.82	98.87	73.79	66.41	166.03	124.52	99.62	71.16	55.34	49.81	110.69	83.01	66.41	47.44	36.90	33.21
40	30	6.93	228.63	171.47	137.18	97.98	76.21	68.59	171.47	128.60	102.88	73.49	57.16	51.44	114.32	85.74	68.59	48.99	38.11	34.29
	40	8.00	264.00	198.00	158.40	113.14	88.00	79.20	198.00	148.50	118.80	84.86	66.00	59.40	132.00	99.00	79.20	56.57	44.00	39.60
	50	8.94	295.16	221.37	177.10	126.50	98.39	88.55	221.37	166.03	132.82	94.87	73.79	66.41	147.58	110.69	88.55	63.25	49.19	44.27
50	30	8.66	285.79	214.34	171.47	122.48	95.26	85.74	214.34	160.76	128.60	91.86	71.45	64.30	142.89	107.17	85.74	61.24	47.63	42.87
	40	10.00	330.00	247.50	198.00	141.43	110.00	99.00	247.50	185.63	148.50	106.07	82.50	74.25	165.00	123.75	99.00	70.71	55.00	49.50
	50	11.18	368.95	276.72	221.37	158.12	122.98	110.69	276.72	207.54	166.03	118.59	92.24	83.01	184.48	138.36	110.69	79.06	61.49	55.34
60	30	10.39	342.95	257.21	205.77	146.98	114.32	102.88	257.21	192.91	154.33	110.23	85.74	77.16	205.77	154.33	123.46	88.19	68.59	61.73
	40	12.00	396.00	297.00	237.60	169.71	132.00	118.80	297.00	222.75	178.20	127.29	99.00	89.10	198.00	148.50	118.80	84.86	66.00	59.40
	50	13.42	442.75	332.06	265.65	189.75	147.58	132.82	332.06	249.04	199.24	142.31	110.69	99.62	221.37	166.03	132.82	94.87	73.79	66.41

Spray Quality Classification	VMD
Medium (M)	236-340
Coarse (C)	341-403
Very Coarse (VC)	404-502
Extremely Coarse (XC)	503-665
Ultra Coarse (UC)	>665

[This chart uses the ASABE S572.1 Standard.]

Data for CPs Floater Turbo 3-Way Nozzles developed by Dr. Womac, Ph.D., P.E., Assoc. Prof. University of Tennessee Institute of Agriculture, Knoxville, TN (Malvern Laser diffraction instrument, still air)

Published January 2024, © Transland.

# Spray Classifications: CP-55R3 and CP-102R3

Regular Volume Floater (CP-55R3) and Combo Floater (CP-102R3)



Orifice & Deflection	PSI	GPM	ASABE Classification	VMD Microns
5 Small (S)	30	0.87	C	374
	40	1.00	C	354
	50	1.12	C	365
10 Medium (M)	30	1.73	VC	445
	40	2.00	VC	447
	50	2.24	VC	486
10 Small (S)	30	1.73	VC	412
	40	2.00	VC	413
	50	2.24	VC	457
15 Medium (M)	30	2.60	XC	515
	40	3.00	XC	503
	50	3.35	C	393
20 Small (S)	30	3.46	XC	504
	40	4.00	XC	504
	50	4.47	XC	504
20 Medium (M)	30	3.46	XC	534
	40	4.00	XC	516
	50	4.47	VC	406
30 Large (L)	30	5.20	XC	518
	40	6.00	VC	501
	50	6.71	VC	482
30 Medium (M)	30	5.20	XC	520
	40	6.00	VC	498
	50	6.71	VC	432
40 Large (L)	30	6.93	VC	491
	40	8.00	VC	488
	50	8.94	VC	462
50 Large (L)	30	8.66	XC	507
	40	10.00	XC	511
	50	11.18	VC	479
60 Large (L)	30	10.39	XC	507
	40	12.00	VC	465
	50	13.42	VC	462



Spray Quality Classification	VMD
Medium (M)	236-340
Coarse (C)	341-403
Very Coarse (VC)	404-502
Extremely Coarse (XC)	503-665
Ultra Coarse (UC)	>665

This chart uses the ASABE S572.1 Standard.

Data for CP-55R3 & CP-102R3 Turbo Floater 3-Way nozzles developed by Dr. Womac, PhD, P.E. Assoc. Prof, University of Tennessee Institute of Agriculture, Knoxville, TN. (Malvern laser diffraction instrument, still air) Nozzle Classification using ASABE S572.1 Standard.



# GPA Chart: CP-59LS and CP-109LS

## Low Volume Floater Turbo Nozzles and Combos

Orifice/Tip Combinations			Gallons Per Acre														
			30" Spacing					40" Spacing					60" Spacing				
Orifice and Tip #	PSI	Nozzle GPM	10 MPH	12 MPH	14 MPH	16 MPH	18 MPH	10 MPH	12 MPH	14 MPH	16 MPH	18 MPH	10 MPH	12 MPH	14 MPH	16 MPH	18 MPH
2.5 #7.5 & #5	30	0.43	8.5	7.1	6.1	5.3	4.7	6.4	5.3	4.6	4.0	3.6	4.3	3.6	3.1	2.7	2.4
	40	0.5	9.9	8.3	7.1	6.2	5.5	7.4	6.2	5.3	4.6	4.1	5.0	4.2	3.6	3.1	2.8
	50	0.56	11.1	9.2	7.9	6.9	6.2	8.3	6.9	5.9	5.2	4.6	5.6	4.6	4.0	3.5	3.1
5 #7.5	30	0.87	17.2	14.3	12.3	10.7	9.5	12.9	10.7	9.2	8.0	7.1	8.6	7.2	6.2	5.4	4.8
	40	1.00	19.8	16.5	14.1	12.4	11.0	14.9	12.4	10.6	9.3	8.3	10.0	8.3	7.1	6.2	5.5
	50	1.12	22.1	18.5	15.8	13.8	12.3	16.6	13.8	11.9	10.4	9.2	11.1	9.3	7.9	6.9	6.2
7.5 #18	30	1.30	25.7	21.4	18.4	16.1	14.3	19.3	16.1	13.8	12.1	10.7	12.9	10.7	9.2	8.1	7.2
	40	1.50	29.7	24.8	21.2	18.6	16.5	22.3	18.6	15.9	13.9	12.4	14.9	12.4	10.6	9.3	8.3
	50	1.68	33.2	27.7	23.7	20.8	18.5	24.9	20.8	17.8	15.6	13.8	16.6	13.9	11.9	10.4	9.3
7.5 #7.5	30	0.94	18.6	15.5	13.3	11.7	10.4	14.0	11.7	10.0	8.7	7.8	9.3	7.8	6.7	5.9	5.2
	40	1.09	21.7	18.1	15.5	13.5	12.0	16.3	13.5	11.6	10.2	9.0	10.9	9.1	7.8	6.8	6
	50	1.22	24.2	20.2	17.3	15.1	13.5	18.2	15.1	13.0	11.4	10.1	12.1	10.1	8.7	7.6	6.8
10 #18	30	1.73	34.3	28.6	24.5	21.4	19.1	25.7	21.4	18.4	16.1	14.3	17.2	14.3	12.3	10.7	9.6
	40	2.00	39.6	33.0	28.3	24.8	22.0	29.7	24.8	21.2	18.6	16.5	19.8	16.5	14.2	12.4	11
	50	2.24	44.3	36.9	31.6	27.7	24.6	33.2	27.7	23.7	20.8	18.5	22.2	18.5	15.8	13.9	12.3
10 #7.5	30	1.25	24.7	20.6	17.7	15.5	13.7	18.6	15.5	13.3	11.6	10.3	12.4	10.3	8.9	7.8	6.9
	40	1.45	28.8	24.0	20.5	18.0	16.0	21.6	18.0	15.4	13.5	12.0	14.4	12	10.3	9	8
	50	1.62	32.2	26.8	23.0	20.1	17.9	24.1	20.1	17.2	15.1	13.4	16.1	13.4	11.5	10.1	9
15 #18	30	2.60	51.4	42.9	36.7	32.2	28.6	38.6	32.2	27.6	24.1	21.4	25.7	21.5	18.4	16.1	14.3
	40	3.00	59.4	49.5	42.4	37.1	33.0	44.6	37.1	31.8	27.8	24.8	29.7	24.8	21.2	18.6	16.5
	50	3.35	66.4	55.3	47.4	41.5	36.9	49.8	41.5	35.6	31.1	27.7	33.2	27.7	23.7	20.8	18.5
15 #7.5	30	1.27	25.1	20.9	17.9	15.7	13.9	18.8	15.7	13.4	11.8	10.5	12.6	10.5	9	7.9	7
	40	1.47	29.2	24.3	20.8	18.2	16.2	21.9	18.2	15.6	13.7	12.2	14.6	12.2	10.4	9.1	8.1
	50	1.65	32.6	27.2	23.3	20.4	18.1	24.5	20.4	17.5	15.3	13.6	16.3	13.6	11.7	10.2	9.1
20 #35	30	3.46	68.6	57.2	49.0	42.9	38.1	51.4	42.9	36.7	32.2	28.6	34.3	28.6	24.5	21.5	19.1
	40	4.00	79.2	66.0	56.6	49.5	44.0	59.4	49.5	42.4	37.1	33.0	39.6	33	28.3	24.8	22
	50	4.47	88.6	73.8	63.3	55.3	49.2	66.4	55.3	47.4	41.5	36.9	44.3	36.9	31.7	27.7	24.6
20 #18	30	2.56	50.8	42.3	36.3	31.7	28.2	38.1	31.7	27.2	23.8	21.2	25.4	21.2	18.2	15.9	14.1
	40	2.98	59.0	49.2	42.2	36.9	32.8	44.3	36.9	31.6	27.7	24.6	29.5	24.6	21.1	18.5	16.4
	50	3.33	66.0	55.0	47.1	41.2	36.7	49.5	41.2	35.4	30.9	27.5	33	27.5	23.6	20.6	18.4
24 #35	30	4.16	82.3	68.6	58.8	51.4	45.7	61.7	51.4	44.1	38.6	34.3	41.2	34.3	29.4	25.7	22.9
	40	4.80	95.0	79.2	67.9	59.4	52.8	71.3	59.4	50.9	44.6	39.6	47.5	39.6	34	29.7	26.4
	50	5.37	106.3	88.6	75.9	66.4	59.0	79.7	66.4	56.9	49.8	44.3	53.2	44.3	38	33.2	30
24 #18	30	2.85	56.4	47.0	40.3	35.2	31.3	42.3	35.2	30.2	26.4	23.5	28.2	23.5	20.2	17.6	15.7
	40	3.31	65.6	54.6	46.8	41.0	36.4	49.2	41.0	35.1	30.7	27.3	32.8	27.3	23.4	20.5	18.2
	50	3.70	73.3	61.1	52.4	45.8	40.7	55.0	45.8	39.3	34.4	30.5	36.7	30.6	26.2	22.9	20.4
30 #35	30	5.20	102.9	85.7	73.5	64.3	57.2	77.2	64.3	55.1	48.2	42.9	51.5	42.9	36.8	32.2	28.6
	40	6.00	118.8	99.0	84.9	74.3	66.0	89.1	74.3	63.6	55.7	49.5	59.4	49.5	42.5	37.2	33
	50	6.71	132.8	110.7	94.9	83.0	73.8	99.6	83.0	71.2	62.3	55.3	66.4	55.4	47.5	41.5	36.9
30 #18	30	2.99	59.1	49.3	42.2	36.9	32.8	44.3	36.9	31.7	27.7	24.6	29.6	24.7	21.1	18.5	16.4
	40	3.47	68.7	57.3	49.1	43.0	38.2	51.6	43.0	36.8	32.2	28.6	34.4	28.7	24.6	21.5	19.1
	50	3.88	76.9	64.0	55.0	48.0	42.7	57.6	48.0	41.2	36.0	32.0	38.5	32	27.5	24	21.4

Data for CP's Low Volume Sprayer Turbo Nozzles developed by Dr. Wornac, Ph.D., P.E., Assoc. Prof., University of Tennessee Institute of Agriculture, Knoxville, TN Nozzle Classification Using ASAE Reference Nozzle Set #5 & 6 (Malvern laser diffraction instrument, still air)

*\*Always read the product label to determine which spray quality is required*

Spray Quality Classification*	VMD
Medium ( M )	Between 236-340
Coarse ( C )	Between 341-403
Very Coarse ( VC )	Between 404-502
Extremely Coarse ( XC )	Between 503-665
Ultra Coarse ( UC )	Over 665



# Spray Classifications: CP-59LS and CP-109LS

## Low Volume Floater Turbo Nozzles and Combos

In column 1, the shaded areas indicate alternate Orifice/Tip combinations.

Orifice and Tip #	PSI	GPM	ASABE Classification	VMD Microns
2.5	30	0.43	UC	922
#7.5 TIP	40	0.5	UC	814
	50	0.56	UC	749
	60	0.61	UC	708
5	30	0.87	XC	529
#7.5	40	1.00	VC	489
	50	1.12	VC	459
	60	1.22	C	396
7.5	30	1.30	UC	810
#18	40	1.50	UC	746
	50	1.68	UC	726
	60	1.83	UC	685
7.5	30	0.94	C	349
#7.5	40	1.09	M	326
	50	1.22	M	312
	60	1.31	M	295
10	30	1.73	UC	717
#18	40	2.00	UC	688
	50	2.24	XC	646
	60	2.45	XC	634
10	30	1.25	M	321
#7.5	40	1.45	M	308
	50	1.62	M	288
	60	1.78	M	285
15	30	2.60	XC	619
#18	40	3.00	XC	603
	50	3.35	XC	594
	60	3.67	XC	581
15	30	1.27	M	283
#7.5	40	1.47	M	273
	50	1.65	M	269
	60	1.80	M	277
20	30	3.46	XC	659
#35	40	4.00	XC	638
	50	4.47	XC	637
	60	4.90	XC	616
20	30	2.56	XC	542
#18	40	2.98	VC	462
	50	3.33	VC	456
	60	3.65	VC	443
24	30	4.16	XC	645
#35	40	4.80	XC	615
	50	5.37	XC	602
	60	5.88	XC	584
24	30	2.85	VC	481
#18	40	3.31	VC	449
	50	3.70	VC	433
	60	4.05	C	388
30	30	5.20	XC	607
#35	40	6.00	XC	591
	50	6.71	XC	575
	60	7.35	XC	560
30	30	2.99	VC	437
#18	40	3.47	C	402
	50	3.88	C	381
	60	4.25	C	360



CP-59LS

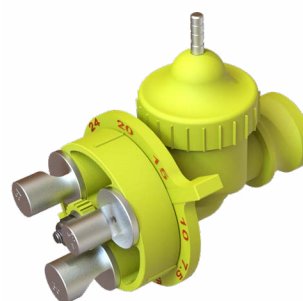

CP-109LS

\*Always read the product label to determine which spray quality is required.

Spray Quality Classifica-	VMD
Medium (M)	Between 236-340
Coarse (C)	Between 341-403
Very Coarse (VC)	Between 404-502
Extremely Coarse (XC)	Between 503-665
Ultra Coarse (UC)	Over 665

Micron range from sample reference graph in ASABE Standard

Data for CP's Low Volume Sprayer Turbo Nozzles developed by Dr. Womac, Ph.D., P.E., Assoc. Prof., University of Tennessee Institute of Agriculture, Knoxville, TN Nozzle Classification Using ASABE Reference Nozzle Set #3 & #6 (Malvern laser diffraction instrument, still air)

# GPA Chart: CP-59HV and CP-109HV High Volume Floater Turbo Nozzles

Orifice/Tip Combinations			Gallons Per Acre														
			30" Spacing					40" Spacing					60" Spacing				
Orifice and Tip #	PSI	Nozzle GPM	10	12	14	16	18	10	12	14	16	18	10	12	14	16	18
			MPH	MPH	MPH	MPH	MPH	MPH	MPH	MPH	MPH	MPH	MPH	MPH	MPH	MPH	MPH
5 #12	30	0.87	17.2	14.3	12.3	10.7	9.5	12.9	10.7	9.2	8.0	7.1	8.6	7.1	6.1	5.4	4.8
	40	1.00	19.8	16.5	14.1	12.4	11.0	14.9	12.4	10.6	9.3	8.3	9.9	8.3	7.1	6.2	5.5
	50	1.12	22.1	18.5	15.8	13.8	12.3	16.6	13.8	11.9	10.4	9.2	11.1	9.2	7.9	6.9	6.2
10 #12	30	1.73	34.3	28.6	24.5	21.4	19.1	25.7	21.4	18.4	16.1	14.3	17.2	14.3	12.3	10.7	9.5
	40	2.00	39.6	33.0	28.3	24.8	22.0	29.7	24.8	21.2	18.6	16.5	19.8	16.5	14.1	12.4	11.0
	50	2.24	44.3	36.9	31.6	27.7	24.6	33.2	27.7	23.7	20.8	18.5	22.1	18.5	15.8	13.8	12.3
15 #35	30	2.60	51.4	42.9	36.7	32.2	28.6	38.6	32.2	27.6	24.1	21.4	25.7	21.4	18.4	16.1	14.3
	40	3.00	59.4	49.5	42.4	37.1	33.0	44.6	37.1	31.8	27.8	24.8	29.7	24.8	21.2	18.6	16.5
	50	3.35	66.4	55.3	47.4	41.5	36.9	49.8	41.5	35.6	31.1	27.7	33.0	27.7	23.7	20.8	18.5
15 #12	30	1.69	33.6	28.0	24.0	21.0	18.6	26.2	21.0	18.0	15.7	14.0	16.8	14.0	12.0	10.5	9.3
	40	1.97	39.0	32.5	27.9	24.4	21.7	29.3	24.4	20.9	18.3	16.3	19.5	16.3	13.9	12.2	10.8
	50	2.20	43.6	36.3	31.2	27.3	24.2	32.7	27.3	23.4	20.4	18.2	21.8	18.2	15.6	13.6	12.1
20 #35	30	3.46	68.6	57.2	49.0	42.9	38.1	51.4	42.9	36.7	32.2	28.6	34.3	28.6	24.5	21.4	19.1
	40	4.00	79.2	66.0	56.6	49.5	44.0	59.4	49.5	42.4	37.1	33.0	39.6	33.0	28.3	24.8	22.0
	50	4.47	88.6	73.8	63.3	55.3	49.2	66.4	55.3	47.4	41.5	36.9	44.3	36.9	31.6	27.7	24.6
20 #12	30	1.89	37.5	31.2	26.8	23.4	20.8	28.1	23.4	20.1	17.6	15.6	18.7	15.6	13.4	11.7	10.4
	40	2.20	43.6	36.3	31.1	27.2	24.2	32.7	27.2	23.3	20.4	18.2	21.8	18.2	15.6	13.6	12.1
	50	2.46	48.7	40.6	34.8	30.4	27.1	36.5	30.4	26.1	22.8	20.3	24.4	20.3	17.4	15.2	13.5
30 #35	30	5.20	102.9	85.7	73.5	64.3	57.2	77.2	64.3	55.1	48.2	42.9	51.4	42.9	36.7	32.2	28.6
	40	6.00	118.8	99.0	84.9	74.3	66.0	89.1	74.3	63.6	55.7	49.5	59.4	49.5	42.4	37.1	33.0
	50	6.71	132.8	110.7	94.9	83.0	73.8	99.6	83.0	71.2	62.3	55.3	66.4	55.3	47.4	41.5	36.9
30 #12	30	2.09	41.4	34.5	29.6	25.9	23.0	31.0	25.9	22.2	19.4	17.2	20.7	17.2	14.8	12.9	11.5
	40	2.43	48.1	40.1	34.4	30.1	26.7	36.1	30.1	25.8	22.6	20.1	24.1	20.1	17.2	15.0	13.4
	50	2.72	53.8	44.8	38.4	33.6	29.9	40.4	33.6	28.8	25.2	22.4	26.9	22.4	19.2	16.8	14.9
40 #60	30	6.93	137.2	114.3	98.0	85.7	76.2	102.9	85.7	73.5	64.3	57.2	68.6	57.2	49.0	42.9	38.1
	40	8.00	158.4	132.0	113.1	99.0	88.0	118.8	99.0	84.9	74.3	66.0	79.2	66.0	56.6	49.5	44.0
	50	8.94	177.1	147.6	126.5	110.7	98.4	132.8	110.7	94.9	83.0	73.8	88.6	73.8	63.3	55.3	49.2
40 #35	30	5.28	104.5	87.1	74.6	65.3	58.0	78.3	65.3	56.0	49.0	43.5	52.2	43.5	37.3	32.6	29.0
	40	6.13	121.5	101.2	86.8	75.9	67.5	91.1	75.9	65.1	56.9	50.6	60.7	50.6	43.4	38.0	33.7
	50	6.86	135.8	113.2	97.0	84.9	75.4	101.9	84.9	72.8	63.7	56.6	67.9	56.6	48.5	42.4	37.7
50 #60	30	8.66	171.5	142.9	122.5	107.2	95.3	128.6	107.2	91.9	80.4	71.5	85.7	71.5	61.2	53.6	47.6
	40	10.00	198.0	165.0	141.4	123.8	110.0	148.5	123.8	106.1	92.8	82.5	99.0	82.5	70.7	61.9	55.0
	50	11.18	221.4	184.5	158.0	138.4	123.0	166.0	138.4	118.6	103.8	92.2	110.7	92.2	79.1	69.2	61.5
50 #35	30	5.77	114.3	95.2	81.6	71.4	63.5	85.7	71.4	61.2	53.6	47.6	57.1	47.6	40.8	35.7	31.8
	40	6.71	132.9	110.7	94.9	83.1	73.8	99.7	83.1	71.2	62.3	55.4	66.4	55.4	47.5	41.5	36.9
	50	7.50	148.6	123.8	106.1	92.9	82.5	111.4	92.9	79.6	69.7	61.2	74.3	61.9	53.1	46.4	41.3
60 #60	30	10.39	205.8	171.5	147.0	128.6	114.3	154.3	128.6	110.2	96.5	85.7	102.9	85.7	73.5	64.3	57.2
	40	12.00	237.6	198.0	169.7	148.5	132.0	178.2	148.5	127.3	111.4	99.0	118.8	99.0	84.9	74.3	66.0
	50	13.42	265.7	221.4	189.8	166.0	147.6	199.2	166.0	142.3	124.5	110.7	132.8	110.7	94.9	83.0	73.8
60 #35	30	6.07	120.3	100.2	85.9	75.2	66.8	90.2	75.2	64.4	56.4	50.1	60.1	50.1	43.0	37.6	33.4
	40	7.06	139.8	116.5	99.9	87.4	77.7	104.9	87.4	74.9	65.6	58.3	69.9	58.3	49.9	43.7	38.8
	50	7.90	156.3	130.3	111.7	97.7	86.9	117.3	97.7	83.8	73.3	65.1	78.2	65.1	55.8	48.9	43.4

Data for CP's Low Volume Sprayer Turbo Nozzles developed by Dr. Womac, Ph.D., P.E., Assoc. Prof., University of Tennessee Institute of Agriculture, Knoxville, TN Nozzle Classification Using ASAE Reference Nozzle Set #5 & 6 (Malvern laser diffraction instrument, still air)

\* Always read the product label to determine which spray quality is required

Spray Quality Classification*	VMD
Medium ( M )	Between 236-340
Coarse ( C )	Between 341-403
Very Coarse ( VC )	Between 404-502
Extremely Coarse ( XC )	Between 503-665
Ultra Coarse ( UC )	Over 665

# Spray Classifications: CP-59HV and CP-109HV High Volume Floater Turbo Nozzles & Combos

Orifice and Tip #	PSI	GPM	ASABE Classification	VMD Microns
	30	0.87	UC	795
5	40	1.00	UC	749
#12	50	1.12	XC	662
	60	1.22	XC	653
	30	1.73	XC	530
10	40	2.00	XC	503
#12	50	2.24	VC	491
	60	2.45	VC	468
	30	2.60	UC	768
15	40	3.00	UC	691
#35	50	3.35	XC	629
	60	3.67	XC	593
	30	1.69	VC	449
15	40	1.97	VC	418
#12	50	2.20	VC	413
	60	2.41	C	397
	30	3.46	XC	651
20	40	4.00	XC	607
#35	50	4.47	XC	600
	60	4.90	XC	563
	30	1.89	VC	425
20	40	2.20	C	394
#12	50	2.46	C	372
	60	2.69	C	359
	30	5.20	XC	560
30	40	6.00	XC	552
#35	50	6.71	XC	521
	60	7.35	VC	500
	30	2.09	C	367
30	40	2.43	C	354
#12	50	2.72	C	346
	60	2.98	M	340
	30	6.93	XC	637
40	40	8.00	XC	577
#60	50	8.94	XC	529
	60	9.80	VC	499
	30	5.28	VC	405
40	40	6.13	C	373
#35	50	6.86	C	361
	60	7.51	C	354
	30	8.66	XC	583
50	40	10.00	XC	516
#60	50	11.18	VC	485
	60	12.25	VC	471
	30	5.77	C	366
50	40	6.71	C	360
#35	50	7.50	C	358
	60	8.22	C	355
	30	10.39	XC	517
60	40	12.00	VC	480
#60	50	13.42	VC	430
	60	14.70	C	381
	30	6.07	C	361
60	40	7.06	C	356
#35	50	7.90	C	356
	60	8.65	C	353

In column 1, the shaded areas indicate alternate Orifice/Tip combinations.



CP-59HV



CP-109HV

\*Always read the product label to determine which spray quality is required.

Spray Quality Classifica-	VMD
Medium (M)	Between 236-340
Coarse (C)	Between 341-403
Very Coarse (VC)	Between 404-502
Extremely Coarse (XC)	Between 503-665
Ultra Coarse (UC)	Over 665

Micron range from sample reference graph in ASABE Standard

Data for CP's Low Volume Sprayer Turbo Nozzles developed by Dr. Womac, Ph.D., P.E., Assoc. Prof., University of Tennessee Institute of Agriculture, Knoxville, TN Nozzle Classification Using ASABE Reference Nozzle Set #3 & #6 (Malvern laser diffraction instrument, still air)

# GPA Chart: CP-65T-SL

## Low Volume Sprayer Turbo Nozzle

Orifice and Tip #	PSI	Nozzle GPM	Gallons per Acre--20 Inch Spacing									
			5 MPH	6 MPH	7 MPH	8 MPH	9 MPH	10 MPH	12 MPH	14 MPH	16 MPH	18 MPH
1.5 #2 Tip	30	0.13	7.7	6.4	5.5	4.8	4.3	3.9	3.2	2.8	2.4	2.1
	40	0.15	8.9	7.4	6.4	5.6	5.0	4.5	3.7	3.2	2.8	2.5
	50	0.17	10.0	8.3	7.1	6.2	5.5	3.9	4.2	3.6	3.1	2.8
2 #2 Tip	30	0.17	10.3	8.6	7.4	6.4	5.7	5.1	4.3	3.7	3.2	2.9
	40	0.2	11.9	9.9	8.5	7.4	6.6	5.9	5.0	4.2	3.7	3.3
	50	0.22	13.3	11.1	9.5	8.3	7.4	6.6	5.5	4.7	4.2	3.7
3 #4 Tip	30	0.26	15.4	12.9	11.0	9.7	8.6	7.7	6.4	5.5	4.8	4.3
	40	0.3	17.8	14.9	12.7	11.1	9.9	8.9	7.4	6.4	5.6	5.0
	50	0.34	19.9	16.6	14.2	12.5	11.1	10.0	8.3	7.1	6.2	5.5
3 #2 Tip	30	0.19	11.1	9.3	7.9	6.9	6.2	5.6	4.6	4.0	3.5	3.1
	40	0.22	12.8	10.7	9.2	8.0	7.1	6.4	5.4	4.6	4.0	3.6
	50	0.24	14.3	12.0	10.3	9.0	8.0	7.2	6.0	5.1	4.5	4.0
3 #6 Tip	30	0.28	16.7	13.9	11.9	10.5	9.3	8.4	7.0	6.0	5.2	4.6
	40	0.33	19.3	16.1	13.8	12.1	10.7	9.7	8.0	6.9	6.0	6.4
	50	0.36	21.6	18.0	15.4	13.5	12.0	10.8	9.0	7.7	6.7	6.0
4 #4 Tip	30	0.35	20.6	17.2	14.7	12.9	11.4	10.3	8.6	7.4	6.4	5.7
	40	0.4	23.8	19.8	17.0	14.9	13.2	11.9	9.9	8.5	7.4	6.6
	50	0.45	26.6	22.1	19.0	16.6	14.8	13.3	11.1	9.5	8.3	7.4
4 #2 Tip	30	0.21	12.6	10.5	9.0	7.9	7.0	6.3	5.3	4.5	3.9	3.5
	40	0.25	14.6	12.1	10.4	9.1	8.1	7.3	6.1	5.2	4.6	4.0
	50	0.27	16.3	13.6	11.6	10.2	9.0	8.1	6.8	5.8	5.1	4.5
4 #6 Tip	30	0.4	23.9	19.9	17.1	15.0	13.3	12.0	10.0	8.5	7.5	6.6
	40	0.47	27.6	23.0	19.7	17.3	15.4	13.8	11.5	9.9	8.6	7.7
	50	0.52	30.9	25.7	22.1	19.3	17.2	15.4	12.9	11.0	9.7	8.6
5 #6 Tip	30	0.43	25.7	21.4	18.4	16.1	14.3	12.9	10.7	9.1	8.0	7.1
	40	0.5	29.7	24.8	21.2	18.6	16.5	14.9	12.4	10.6	9.3	8.3
	50	0.56	33.2	27.7	23.7	20.8	18.5	16.6	13.8	11.9	10.4	9.2
5 #2 Tip	30	0.22	13.1	10.9	9.3	8.2	7.3	6.5	5.4	4.7	4.1	3.6
	40	0.25	15.1	12.6	10.8	9.4	8.3	7.5	6.3	5.4	4.7	4.2
	50	0.28	16.9	14.1	12.1	10.5	9.4	8.4	7.0	6.0	5.3	4.7
5 #4 Tip	30	0.38	22.6	18.9	16.2	14.2	12.6	11.3	9.4	8.1	7.1	6.3
	40	0.44	26.3	21.9	18.8	16.5	14.6	13.2	11.0	9.4	8.2	7.3
	50	0.49	29.2	24.4	20.9	18.3	16.2	14.6	12.2	10.4	9.1	8.1
6 #6 Tip	30	0.52	30.9	25.7	22.1	19.3	17.2	15.4	12.9	11.0	9.7	8.6
	40	0.6	35.6	29.7	25.5	22.3	19.8	17.8	14.9	12.7	11.1	9.9
	50	0.67	39.9	33.2	28.5	24.9	22.1	19.9	16.6	14.2	12.5	11.1
6 #2 Tip	30	0.22	13.6	11.3	9.7	8.5	7.5	6.8	5.7	4.9	4.2	3.8
	40	0.25	15.7	13.1	11.2	9.8	8.7	7.8	6.5	5.6	4.9	4.4
	50	0.28	17.5	14.6	12.5	11.0	9.7	8.8	7.3	6.3	5.5	7.9
6 #4 Tip	30	0.38	24.2	20.2	17.3	15.1	13.4	12.1	10.1	8.6	7.6	6.7
	40	0.44	27.9	23.3	19.9	17.5	15.5	14.0	11.6	10.0	8.7	7.8
	50	0.49	31.2	26.0	22.3	19.5	17.3	15.6	13.0	11.2	9.8	8.7

Droplet Size data derived mathematical models as reported in "Fritz, B.K., Hoffmann, W.C. and Anderson, J. 2015. Response Surface Method for Evaluation of Agricultural Application Nozzles. STP from 36th Symposium Pesticide Formulations and Delivery Systems: Pesticides and Adjuvant Formulations in 2014." Southern Plains Agricultural Research Center, Agricultural Research Service, U.S. Department of Agriculture, 3103 FFB Road, College Station, TX 77845, USA

Spray Quality Classifica-	VMD
Fine ( F )	Between 106-235
Medium ( M )	Between 236-340
Coarse ( C )	Between 341-403
Very Coarse ( VC )	Between 404-502
Extremely Coarse ( XC )	Between 503-665
Ultra Coarse ( UC )	Over 665

\*Always read the product label to determine which spray quality is required.



# Spray Classifications: CP-65T-SL

## Low Volume Sprayer Turbo Nozzle

Orifice and Tip #	PSI	Nozzle GPM	ASABE Classification	VMD Microns
1.5 #2 Tip	30	0.13	VC	466
	40	0.15	VC	495
	50	0.17	VC	433
2 #2 Tip	30	0.17	C	370
	40	0.2	VC	406
	50	0.22	C	352
3 #4 Tip	30	0.26	XC	617
	40	0.3	XC	660
	50	0.34	XC	612
3 #2 Tip	30	0.19	F	228
	40	0.22	M	280
	50	0.24	M	241
3 #6 Tip	30	0.28	UC	718
	40	0.33	UC	751
	50	0.36	UC	694
4 #4 Tip	30	0.35	VC	472
	40	0.4	XC	531
	50	0.45	VC	498
4 #2 Tip	30	0.21	F	153
	40	0.25	F	221
	50	0.27	F	198
4 #6 Tip	30	0.4	XC	504
	40	0.47	XC	553
	50	0.52	XC	511
5 #6 Tip	30	0.43	C	357
	40	0.5	VC	422
	50	0.56	C	396
5 #2 Tip	30	0.22	F	146
	40	0.25	F	229
	50	0.28	F	221
5 #4 Tip	30	0.38	C	395
	40	0.44	VC	469
	50	0.49	VC	452
6 #6 Tip	30	0.52	M	278
	40	0.6	C	358
	50	0.67	C	347
6 #2 Tip	30	0.22	F	206
	40	0.25	M	305
	50	0.28	M	312
6 #4 Tip	30	0.38	C	386
	40	0.44	VC	475
	50	0.49	VC	474

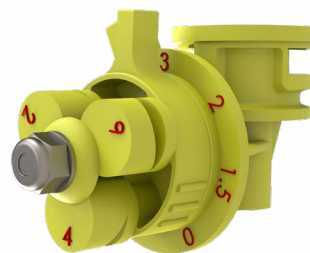

CP-65T-SL

\*Always read the product label to determine which spray quality is required.

Spray Quality Classification	VMD
Fine (F)	Between 106-235
Medium (M)	Between 236-340
Coarse (C)	Between 341-403
Very Coarse (VC)	Between 404-502
Extremely Coarse (XC)	Between 503-665
Ultra Coarse (UC)	Over 665

Micron range from sample reference graph in ASABE Standard

Droplet Size data derived mathematical models as reported in "Fritz, B.K., Hoffmann, W.C and Anderson, J. 2015. Response Surface Method for Evaluation of Agricultural Application Nozzles. STP from 35th Symposium Pesticide Formulations and Delivery Systems: Pesticides and Adjuvant Formulations in 2014." Southern Plains Agricultural Research Center, Agricultural Research

# GPA Chart: CP-65T-S

## Standard Volume Sprayer Turbo Nozzle

Spray Quality Classifica-		VMD
Coarse (C)		Between 341-403
Very Coarse (VC)		Between 404-502
Extremely Coarse (XC)		Between 503-665
Ultra Coarse (UC)		Over 665

Orifice and # Tip	PSI	Nozzle GPM	20" Spacing -- Gallons Per Acre							30" Spacing						
			6 MPH	8 MPH	10 MPH	12 MPH	14 MPH	16 MPH	18 MPH	6 MPH	8 MPH	10 MPH	12 MPH	14 MPH	16 MPH	18 MPH
3 #3 Tip	30	0.26	12.9	9.7	7.7	6.4	5.5	4.8	4.3	8.6	6.4	5.1	4.3	3.7	3.2	2.9
	40	0.3	14.9	11.1	8.9	7.4	6.4	5.6	5.0	9.9	7.4	5.9	5.0	4.2	3.7	3.3
	50	0.34	16.6	12.5	10.0	8.3	7.1	6.3	5.5	11.1	8.3	6.6	5.5	4.7	4.2	3.7
3 #7.5 Tip	30	0.27	13.6	10.2	8.1	6.8	5.8	5.1	4.5	9.0	6.8	5.4	4.5	3.9	3.4	3.0
	40	0.32	15.7	11.7	9.4	7.8	6.7	5.9	5.2	10.4	4.8	6.3	5.2	4.5	3.9	3.5
	50	0.35	17.5	13.1	10.5	8.8	7.5	6.6	5.8	11.7	8.8	7.0	5.8	5.0	4.4	3.9
4 #7.5 Tip	30	0.35	17.3	13.0	10.4	8.7	7.4	6.5	5.8	11.6	8.7	6.9	5.8	5.0	4.3	3.9
	40	0.4	19.8	14.9	11.9	9.9	8.5	7.4	6.6	13.2	9.9	7.9	6.6	5.7	5.0	4.4
	50	0.45	22.3	16.7	13.4	11.1	9.6	8.4	7.4	14.9	11.1	8.9	7.4	6.4	5.6	5.0
4 #3 Tip	30	0.33	16.5	12.4	9.9	8.3	7.1	6.2	5.5	11.0	8.3	6.6	5.5	4.7	4.1	3.7
	40	0.39	19.1	14.3	11.4	9.5	8.2	7.2	6.4	12.7	9.5	7.6	6.4	5.5	4.8	4.2
	50	0.43	21.3	16.0	12.8	10.7	9.1	8.0	7.1	14.2	10.7	8.5	7.1	6.1	5.3	4.7
4 #10 Tip	30	0.37	18.2	163.7	10.9	9.1	7.8	6.8	6.1	12.1	9.1	7.3	6.1	5.2	4.6	4.1
	40	0.42	21.0	15.8	12.6	10.5	9.0	7.9	7.0	14.0	10.5	8.4	7.0	6.0	5.3	4.7
	50	0.47	23.5	17.6	14.1	11.8	10.1	8.8	7.8	15.7	11.8	9.4	7.8	6.7	5.9	5.2
5 #7.5 Tip	30	0.43	21.4	16.1	12.9	10.7	9.2	8.0	7.1	14.3	10.7	8.6	7.1	6.1	5.4	4.8
	40	0.5	24.8	18.6	14.9	12.4	10.6	9.3	8.3	16.5	12.4	9.9	8.3	7.1	6.2	5.5
	50	0.56	27.7	20.8	16.6	13.8	11.9	10.4	9.2	18.5	13.8	11.1	9.2	7.9	6.9	6.2
5 #3 Tip	30	0.41	20.4	15.3	12.2	10.2	8.7	7.7	6.8	13.6	10.2	8.2	6.8	5.8	5.1	4.5
	40	0.48	23.5	17.7	14.1	11.8	10.1	8.8	7.9	15.7	11.8	9.4	7.9	6.7	5.9	5.2
	50	0.53	26.3	19.7	15.8	13.2	11.3	9.9	8.8	17.6	13.2	10.5	8.8	7.5	6.7	5.9
5 #10 Tip	30	0.48	23.7	17.7	14.2	11.8	10.1	8.9	7.9	15.8	11.8	9.5	7.9	6.8	5.9	5.3
	40	0.55	27.3	20.5	16.4	13.7	11.7	10.2	9.1	18.2	13.7	10.9	9.1	7.8	6.8	6.1
	50	0.62	30.5	22.9	18.3	15.3	13.1	11.5	10.2	20.4	15.3	12.2	10.2	8.7	7.6	6.8
6 #7.5 Tip	30	0.52	25.7	19.3	15.4	12.9	11.0	9.7	8.6	17.2	12.9	10.3	8.6	7.4	6.4	5.7
	40	0.6	29.7	22.3	17.8	14.9	12.7	11.1	9.9	19.8	14.9	11.9	9.9	8.5	7.4	6.6
	50	0.67	33.2	24.9	19.9	16.6	14.2	12.5	11.1	22.1	16.6	13.3	11.1	9.5	8.3	7.4
6 #3 Tip	30	0.46	22.9	17.2	13.8	11.5	9.8	8.6	7.6	15.3	11.5	9.2	7.6	6.6	5.7	5.1
	40	0.53	26.5	19.9	15.9	13.2	11.4	9.9	8.8	17.7	13.2	10.6	8.8	7.6	6.6	5.9
	50	0.6	29.6	22.2	17.8	14.8	12.7	11.1	9.9	19.7	14.8	11.8	9.9	8.5	7.4	6.6
6 #10 Tip	30	0.56	27.6	20.7	16.5	13.8	11.8	10.3	9.2	18.4	13.8	11.0	9.2	7.9	6.9	6.1
	40	0.64	31.8	23.9	19.1	15.9	13.6	11.9	10.6	21.2	15.9	12.7	10.6	9.1	8.0	7.1
	50	0.75	37.3	28.0	22.4	18.7	16.0	14.0	12.4	24.9	18.7	14.9	12.4	10.7	9.3	8.3
8 #10 Tip	30	0.69	34.3	25.7	20.6	17.2	14.7	12.9	11.4	22.9	17.2	13.7	11.4	9.8	8.6	7.6
	40	0.8	39.6	29.7	23.8	19.8	17.0	14.9	13.2	26.4	19.8	15.8	13.2	11.3	9.9	8.8
	50	0.89	44.3	33.2	26.6	22.1	19.0	16.6	14.8	29.5	22.1	17.7	14.8	12.7	11.1	9.8
8 #3 Tip	30	0.55	27.1	20.4	16.3	13.6	11.6	10.2	9.0	18.1	13.6	120.9	9.0	7.8	6.8	6.0
	40	0.63	31.3	23.5	18.8	15.7	13.4	11.8	10.4	20.9	15.7	12.5	10.4	9.0	7.8	7.0
	50	0.71	35.0	26.3	21.0	17.5	15.0	13.1	11.7	23.4	17.5	14.0	11.7	10.0	8.8	7.8
8 #7.5 Tip	30	0.63	31.4	23.5	18.8	15.7	13.5	11.8	10.5	20.9	15.7	12.6	10.5	9.0	7.9	7.0
	40	0.73	36.3	27.2	21.8	18.1	15.5	13.6	12.1	24.2	18.1	14.5	12.1	10.4	9.1	8.1
	50	0.82	40.5	30.4	24.3	20.3	17.4	15.2	13.5	27.0	20.3	16.2	13.5	11.6	10.1	9.0
10 #10 Tip	30	0.87	42.9	32.2	25.7	21.4	18.4	16.1	14.3	28.6	21.4	17.2	14.3	12.3	10.7	9.5
	40	1	49.5	37.1	29.7	24.8	21.2	18.6	16.5	33.0	24.8	19.8	16.5	14.1	12.4	11.0
	50	1.12	55.3	41.5	33.2	27.7	23.7	20.8	18.5	36.9	27.7	22.1	18.5	15.8	13.8	12.3
10 #3 Tip	30	0.6	29.7	22.3	17.8	14.9	12.7	11.1	9.9	19.8	14.9	11.9	9.9	8.5	7.4	6.6
	40	0.69	34.3	25.7	20.6	17.2	14.7	12.9	11.4	22.9	17.2	13.7	11.4	9.8	8.6	7.6
	50	0.77	38.4	28.8	23.0	19.2	16.4	14.4	12.8	25.6	19.2	15.3	12.8	11.0	9.6	8.5
10 #7.5 Tip	30	0.74	36.5	27.4	21.9	18.3	15.6	13.7	12.2	24.3	18.3	14.6	12.2	10.4	9.1	8.1
	40	0.85	42.2	31.6	25.3	21.1	18.1	15.8	14.1	28.1	21.1	16.9	14.1	12.0	10.5	9.4
	50	0.95	47.1	35.3	28.3	23.6	20.2	17.7	15.7	31.4	23.6	18.9	15.7	13.5	11.8	10.5

# Spray Classifications: CP-65T-S

## Standard Volume Sprayer Turbo Nozzle

In column 1, the shaded areas indicate alternate Orifice/Tip combinations.

Orifice and Tip #	PSI	Nozzle Capacity GPM	ASABE Classification	VMD
3	30	0.26	UC	945
	40	0.3	UC	845
	50	0.34	UC	777
#3 Tip	30	0.27	UC	1283
	40	0.32	UC	1177
	50	0.35	UC	1104
4	30	0.35	UC	1102
	40	0.4	UC	1001
	50	0.45	UC	932
#7.5 Tip	30	0.33	UC	797
	40	0.39	UC	701
	50	0.43	XC	636
4	30	0.37	UC	1298
	40	0.42	UC	1194
	50	0.47	UC	1122
#10 Tip	30	0.43	UC	945
	40	0.5	UC	848
	50	0.56	UC	783
5	30	0.41	UC	672
	40	0.48	XC	580
	50	0.53	XC	520
#3 Tip	30	0.48	UC	1124
	40	0.55	UC	1024
	50	0.62	UC	956
5	30	0.52	UC	813
	40	0.6	UC	720
	50	0.67	XC	659
#7.5 Tip	30	0.46	XC	572
	40	0.53	VC	484
	50	0.6	VC	428
6	30	0.56	UC	973
	40	0.64	UC	878
	50	0.75	UC	814
#10 Tip	30	0.69	UC	745
	40	0.8	XC	658
	50	0.89	XC	603
8	30	0.55	VC	444
	40	0.63	C	365
	50	0.71	M	317
#3 Tip	30	0.63	XC	620
	40	0.73	XC	536
	50	0.82	VC	483
8	30	0.87	XC	613
	40	1	XC	535
	50	1.12	VC	488
#10 Tip	30	0.6	VC	412
	40	0.69	C	341
	50	0.77	M	302
10	30	0.74	XC	524
	40	0.85	VC	448
	50	0.95	C	404
#7.5 Tip				

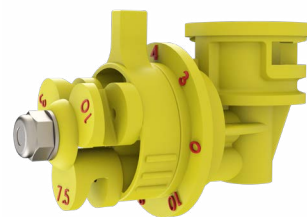

CP-65T-S

\*Always read the product label to determine which spray quality is required.

Spray Quality Classifica-	VMD
Medium (M)	Between 236-340
Coarse (C)	Between 341-403
Very Coarse (VC)	Between 404-502
Extremely Coarse (XC)	Between 503-665
Ultra Coarse (UC)	Over 665

Micron range from sample reference graph in ASABE Standard S572.1.

Droplet Size data derived mathematical models as reported in "Fritz, B.K., Hoffmann, W.C and Anderson, J. 2015. Response Surface Method for Evaluation of Agricultural Application Nozzles. STP from 35th Symposium Pesticide Formulations and Delivery Systems: Pesticides and Adjuvant Formulations in 2014." Southern Plains Agricultural Research Center, Agricultural Research Service, U.S. Department of Agriculture, 3103 F&B Road, College Station, TX 77845, USA

# GPA Chart: CP-65T-SHP

## High Volume Sprayer Turbo Nozzle

Spray Quality Classification*		VMID
Coarse (C)		Between 341-403
Very Coarse (VC)		Between 404-502
Extremely Coarse (XC)		Between 503-665
Ultra Coarse (UC)		Over 665

Orifice and Tip #	PSI	Nozzle GPM	20" Spacing--					30" Spacing					40" Spacing					
			10	12	14	16	18	10	12	14	16	18	10	12	14	16	18	
			MPH	MPH	MPH	MPH	MPH	MPH	MPH	MPH	MPH	MPH	MPH	MPH	MPH	MPH	MPH	
#10	30	0.87	25.7	21.4	18.4	16.1	14.3	17.2	14.3	12.3	10.7	9.5	12.9	10.7	9.2	8.0	7.1	
	#15	40	1	29.7	24.8	21.2	18.6	16.5	19.8	16.5	14.1	12.4	11.0	14.9	12.4	10.6	9.3	8.3
		50	1.12	33.2	37.7	23.7	20.8	18.5	22.1	18.5	15.8	13.8	12.3	16.6	13.8	11.9	10.4	9.2
10	30	0.9	26.8	22.3	19.1	16.7	14.9	17.8	14.9	12.7	11.2	9.9	13.4	11.2	9.6	8.4	7.4	
	#25	40	1.04	30.9	25.7	22.1	19.3	17.2	20.6	17.2	14.7	12.9	11.4	15.4	12.9	11.0	9.7	8.6
		50	1.16	34.5	28.8	24.7	21.6	19.2	23.0	19.2	16.4	14.4	12.8	17.3	14.4	12.3	10.8	9.6
15	30	1.3	38.6	32.2	27.6	24.1	21.4	25.7	21.4	18.4	16.1	14.3	19.3	16.1	13.8	12.1	10.7	
	#15	40	1.5	44.6	37.1	31.8	27.8	24.8	29.7	24.8	21.2	18.6	16.5	22.3	18.6	15.9	13.9	12.4
		50	1.68	49.8	41.5	35.6	31.1	27.7	33.2	27.7	23.7	20.8	18.5	24.9	20.8	17.8	15.6	13.8
15	30	1.38	40.9	34.1	29.2	25.6	22.7	27.3	22.7	19.5	17.0	15.2	20.5	17.0	14.6	12.8	11.4	
	#25	40	1.59	47.2	39.4	33.7	29.5	26.2	31.5	26.2	22.5	19.7	17.5	23.6	19.7	16.9	14.8	13.1
		50	1.78	52.8	44.0	37.7	33.0	29.3	35.2	29.3	25.1	22.0	19.6	26.4	22.0	18.9	16.5	14.7
15	30	1.45	43.2	36.0	30.9	27.0	24.0	28.8	24.0	20.6	18.0	16.0	21.6	18.0	15.4	13.5	12.0	
	#33	40	1.68	49.9	41.6	25.6	31.2	27.7	33.3	27.7	23.8	20.8	18.5	25.0	20.8	17.8	15.6	13.9
		50	1.88	55.8	46.5	39.9	34.9	31.0	37.2	31.0	26.6	23.2	20.7	27.9	23.2	19.9	17.4	15.5
20	30	1.73	51.4	42.9	36.7	32.2	28.6	34.3	28.6	24.5	21.3	19.1	25.7	21.4	18.4	16.1	14.3	
	#25	40	2	59.4	49.5	42.2	37.1	33.0	39.6	33.0	28.3	24.8	22.0	29.7	24.8	21.2	18.6	16.5
		50	2.24	66.4	55.3	47.2	41.5	36.9	44.3	36.9	31.6	27.7	24.6	33.2	27.7	23.7	20.8	18.5
20	30	1.92	57.1	47.6	40.8	35.7	31.7	38.1	31.7	27.2	23.8	21.2	28.6	23.8	20.4	17.8	15.9	
	#33	40	2.22	65.9	55.0	47.1	41.2	36.6	44.0	36.6	31.4	27.5	24.4	33.0	27.5	23.6	20.6	18.3
		50	2.48	73.2	61.4	52.9	46.1	41.0	49.1	41.0	35.1	30.7	27.3	36.9	30.7	26.3	23.0	20.5
20	30	1.72	51.2	42.7	36.6	32.0	28.4	34.1	28.4	24.4	21.3	19.0	25.6	21.3	18.3	16.0	14.2	
	#15	40	1.99	59.1	49.3	42.2	36.9	32.8	39.4	32.8	28.1	24.6	21.9	29.6	24.6	21.1	18.5	16.4
		50	2.22	66.1	55.1	47.2	41.3	36.7	44.1	36.7	31.5	27.5	24.5	33.0	27.5	23.6	20.7	18.4
25	30	2.17	64.3	53.6	45.9	40.2	35.7	42.9	35.7	30.6	26.8	23.8	32.2	26.8	23.0	20.1	17.9	
	#25	40	2.5	74.3	61.9	53.0	46.4	41.3	49.5	41.3	35.4	30.9	27.5	37.1	30.9	26.5	23.2	20.6
		50	2.8	83.0	69.2	59.3	51.9	46.1	55.3	46.1	39.6	34.6	30.8	41.5	34.6	29.7	25.9	23.1
25	30	2.56	76.1	63.5	54.4	47.6	42.3	50.8	42.3	36.3	31.7	28.2	38.1	31.7	27.2	23.8	21.2	
	#33	40	2.96	87.9	73.3	62.8	55.0	48.8	58.6	48.8	41.9	36.6	32.6	44.0	36.6	31.4	27.5	24.4
		50	3.31	98.3	81.9	70.2	61.4	54.6	65.5	54.6	46.8	41.0	36.4	49.1	41.0	35.1	30.7	27.3
25	30	1.98	58.9	49.1	42.1	36.8	32.7	39.3	32.7	28.1	24.5	21.8	29.5	24.5	21.0	18.4	16.4	
	#15	40	2.29	68.0	56.7	54.8	42.5	37.8	45.3	37.8	32.4	28.3	25.2	34.0	28.3	24.3	21.3	18.9
		50	2.56	76.0	63.4	54.3	47.5	42.3	50.7	42.3	36.2	31.7	28.2	38.0	31.7	27.2	23.8	21.1
30	30	2.6	77.2	64.3	55.1	48.2	42.9	51.4	42.9	36.7	32.2	28.6	38.6	32.2	27.6	24.1	21.4	
	#33	40	3	89.1	74.3	63.6	55.7	49.5	59.4	49.5	42.4	37.1	33.0	44.6	37.1	31.8	27.8	24.8
		50	3.35	99.6	83.0	71.2	62.3	55.3	66.4	55.3	47.4	41.5	36.9	49.8	41.5	35.6	31.1	27.7
30	30	2.24	66.6	55.5	47.6	41.6	37.0	44.4	37.0	31.7	27.8	24.7	33.3	27.8	23.8	20.8	18.5	
	#25	40	2.59	76.9	64.1	55.0	48.1	42.7	51.3	42.7	36.6	32.1	28.5	38.5	32.1	27.5	24.0	21.4
		50	2.9	86.0	71.7	61.4	53.8	47.8	57.3	47.8	41.0	35.8	31.9	43.0	35.8	30.7	26.9	23.9
30	30	1.99	59.2	49.3	42.3	37.0	32.9	39.4	32.9	28.2	24.7	21.9	29.6	24.7	21.1	18.5	16.4	
	#15	40	2.3	68.3	56.9	48.8	42.7	38.0	45.5	38.0	32.5	28.5	25.3	34.2	28.5	24.4	21.4	19.0
		50	2.57	76.4	63.6	54.6	47.7	42.4	50.9	42.4	36.4	31.8	28.3	38.2	31.8	27.3	23.9	21.2
33	30	2.86	84.9	70.7	60.6	53.1	47.2	56.7	47.2	40.4	35.4	31.4	42.4	35.4	30.3	26.5	23.6	
	#33	40	3.3	98.0	81.7	70.0	61.3	54.5	65.3	54.5	46.7	40.8	36.3	49.0	40.8	35.0	30.6	27.2
		50	3.69	109.6	91.3	78.3	68.5	60.9	73.1	60.9	52.2	45.7	40.6	54.8	45.7	39.1	34.2	30.4
33	30	2.3	68.4	57.0	48.9	42.8	38.0	45.6	38.0	32.6	28.5	25.3	34.2	28.5	24.4	21.4	19.0	
	#25	40	2.66	79.0	65.8	56.4	49.4	43.9	52.7	43.9	37.6	32.9	29.3	39.5	32.9	28.2	24.7	22.0
		50	2.97	88.3	73.6	63.1	55.2	49.1	58.9	49.1	42.1	36.8	32.7	44.2	36.8	31.6	27.6	24.5
33	30	2.04	60.4	50.4	43.2	37.8	33.6	40.3	33.6	28.8	25.2	22.4	30.2	25.2	21.6	18.9	16.8	
	#15	40	2.35	69.8	58.2	49.9	43.6	38.8	46.5	38.8	33.2	29.1	25.9	34.9	29.1	24.9	21.8	19.4
		50	2.63	78.0	65.0	55.7	48.8	43.4	52.0	43.4	37.2	32.5	28.9	39.0	32.5	27.9	24.4	21.7



# Spray Classifications: CP-65T-SHP

## High Volume Sprayer Turbo Nozzle

Orifice and Tip #	PSI	Nozzle GPM	ASABE Classification	VMD Microns
10 #15 Tip	30	0.87	UC	1005
	40	1	UC	779
	50	1.12	UC	761
10 #25 Tip	30	0.9	UC	1058
	40	1.04	UC	804
	50	1.16	UC	758
10 #33 Tip	30	.9	UC	1360
	40	1.05	UC	1084
	50	1.18	UC	1016
15 #15 Tip	30	1.3	UC	982
	40	1.5	UC	759
	50	1.68	UC	743
15 #25 Tip	30	1.38	UC	1096
	40	1.59	UC	844
	50	1.78	UC	801
15 #33 Tip	30	1.45	UC	1447
	40	1.68	UC	1173
	50	1.88	UC	1107
20 #25 Tip	30	1.73	UC	1078
	40	2	UC	829
	50	2.24	UC	787
20 #15 Tip	30	1.72	UC	904
	40	1.99	UC	682
	50	2.22	UC	669
20 #33 Tip	30	1.92	UC	1478
	40	2.22	UC	1206
	50	2.48	UC	1142
25 #25 Tip	30	2.17	UC	1005
	40	2.5	UC	757
	50	2.8	UC	717
25 #15 Tip	30	1.98	UC	770
	40	2.29	XC	550
	50	2.56	XC	539
25 #33 Tip	30	2.56	UC	1453
	40	2.96	UC	1183
	50	3.31	UC	1121
30 #33 Tip	30	2.6	UC	1372
	40	3	UC	1104
	50	3.35	UC	1044
30 #15 Tip	30	1.99	XC	580
	40	2.3	C	363
	50	2.57	C	353
30 #25 Tip	30	2.24	UC	876
	40	2.59	XC	630
	50	2.9	XC	592
33 #33 Tip	30	2.86	UC	1297
	40	3.3	UC	1030
	50	3.69	UC	971
33 #15 Tip	30	2.04	UC	1297
	40	2.35	UC	1030
	50	2.63	UC	971
33 #25 Tip	30	2.3	XC	771
	40	2.66	XC	527
	50	2.97	VC	490

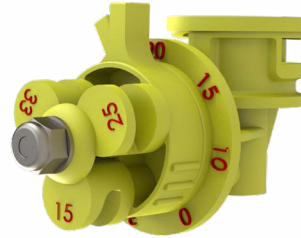

CP-65T-SHP

\*Always read the product label to determine which spray quality is required.

Spray Quality Classifica-	VMD
Medium (M)	Between 236-340
Coarse (C)	Between 341-403
Very Coarse (VC)	Between 404-502
Extremely Coarse (XC)	Between 503-665
Ultra Coarse (UC)	Over 665

Micron range from sample reference graph in ASABE Standard S572.1.

Droplet Size data derived mathematical models as reported in "Fritz, B.K., Hoffmann, W.C and Anderson, J. 2015. Response Surface Method for Evaluation of Agricultural Application Nozzles. STP from 35th Symposium Pesticide Formulations and Delivery Systems: Pesticides and Adjuvant Formulations in 2014." Southern Plains Agricultural Research Center, Agricultural Research Service, U.S. Department of Agriculture, 3103 F&B Road, College Station, TX 77845, USA

# GPA Chart: CPS275T-3SS

## Triple Stream Tip for CP-65s

### CP-65T-S3 STANDARD VOLUME

SPRAYER TURBO NOZZLE

Gallons per Acre **with Triple Stream Tip**  
20" Spacing Only

Orifice	PSI	Nozzle Capacity GPM	6 MPH	8 MPH	10 MPH	12 MPH	14 MPH	16 MPH	18 MPH
#3	25	0.17	8.6	6.5	5.2	4.3	3.7	3.2	2.9
	30	0.19	9.4	7.0	5.7	4.7	4.0	3.5	3.1
	35	0.21	10.2	7.6	6.1	5.1	4.4	3.8	3.4
	40	0.22	10.9	8.2	6.5	5.5	4.7	4.1	3.6
	50	0.25	12.2	9.1	7.3	6.1	5.2	4.6	4.1
	60	0.27	13.3	10.0	8.0	6.7	5.7	5.0	4.5
#4	25	0.29	14.9	10.9	8.7	7.2	6.2	5.4	4.8
	30	0.32	15.9	11.9	9.5	7.9	6.8	6.0	5.3
	35	0.35	17.1	12.8	10.3	8.6	7.3	6.4	5.7
	40	0.37	18.3	13.7	11.0	9.2	7.9	6.9	6.1
	50	0.41	20.5	15.4	12.3	10.2	8.8	7.7	6.8
	60	0.45	22.4	16.8	13.5	11.2	9.6	8.4	7.5
#5	25	0.41	20.4	15.3	12.2	10.2	8.7	7.6	6.8
	30	0.45	22.3	16.7	13.4	11.2	9.6	8.4	7.4
	35	0.49	24.1	18.1	14.5	12.0	10.3	9.0	8.0
	40	0.52	25.7	19.3	15.4	12.9	11.0	9.7	8.6
	50	0.58	28.8	21.6	17.3	14.4	12.3	10.8	9.6
	60	0.64	31.5	23.6	18.9	15.8	13.5	11.8	10.5
#6	25	0.55	27.4	20.5	16.4	13.7	11.7	10.3	9.1
	30	0.61	30.0	22.5	18.0	15.0	12.9	11.3	10
	35	0.65	32.4	24.3	19.5	16.2	13.9	12.2	10.8
	40	0.70	34.7	26.0	20.8	17.3	14.9	13.0	11.6
	50	0.78	38.7	29.1	23.2	19.4	16.6	14.5	12.9
	60	0.86	42.4	31.8	25.5	21.2	18.2	15.9	14.2
#8	25	0.64	31.7	23.8	19.0	15.9	13.6	11.9	10.6
	30	0.70	34.7	26.0	20.8	17.4	14.9	13.0	11.6
	35	0.76	37.5	28.1	22.5	18.8	16.1	14.1	12.5
	40	0.81	40.1	30.1	24.1	20.1	17.2	15.0	13.4
	50	0.91	44.8	33.6	26.9	22.4	19.2	16.8	14.9
	60	0.99	49.1	36.8	29.5	24.6	21.1	18.4	16.4
#10	25	0.87	43.0	32.3	25.8	21.5	18.5	16.1	14.4
	30	0.95	47.2	35.4	28.3	23.6	20.2	17.7	15.7
	35	1.03	50.9	38.2	30.6	25.5	21.8	19.1	17.0
	40	1.10	54.5	40.8	32.7	27.2	23.3	20.4	18.2
	50	1.23	60.9	45.7	36.5	30.4	26.1	22.8	20.3
	60	1.35	66.7	50.0	40.0	33.3	28.6	25.0	22.2

### CP-65T-SL3 LOW VOLUME

SPRAYER TURBO NOZZLE

Gallons per Acre **with Triple Stream Tip**  
20" Spacing Only

Orifice	PSI	Nozzle Capacity GPM	6 MPH	8 MPH	10 MPH	12 MPH	14 MPH	16 MPH	18 MPH
1.5	20	0.11	5.3	3.9	3.2	2.6	2.3	2.0	1.8
	25	0.12	5.9	4.4	3.5	2.9	2.5	2.2	2.0
	30	0.13	6.4	4.8	3.9	3.2	2.8	2.4	2.1
	35	0.14	7.0	5.2	4.2	3.5	3.0	2.6	2.3
	40	0.15	7.4	5.6	4.5	3.7	3.2	2.8	2.5
	50	0.17	8.3	6.1	5.0	4.2	3.6	3.1	2.8
60	0.18	9.1	6.8	5.5	4.6	3.9	3.4	3.0	
2	20	0.19	9.5	7.1	5.7	4.7	4.1	3.5	3.2
	25	0.21	10.6	7.9	6.3	5.3	4.5	4.0	3.5
	30	0.23	11.6	8.7	7.0	5.8	5.0	4.3	3.9
	35	0.25	12.5	9.4	7.5	6.3	5.4	4.7	4.2
	40	0.27	13.4	10.0	8.0	6.7	5.7	5.0	4.5
	50	0.30	14.9	11.2	9.0	7.5	6.4	5.6	5.0
60	0.33	16.4	12.3	9.9	8.2	7.0	6.1	5.5	
3	20	0.22	10.9	8.1	6.5	5.4	4.7	4.0	3.7
	25	0.25	12.1	9.1	7.3	6.1	5.2	4.6	4.0
	30	0.27	13.3	10.0	8.0	6.6	5.7	5.0	4.4
	35	0.29	14.4	10.8	8.6	7.2	6.2	5.4	4.8
	40	0.31	15.4	11.5	9.2	7.7	6.6	5.8	5.1
	50	0.35	17.1	12.9	10.3	8.6	7.4	6.4	5.7
60	0.38	18.8	14.1	11.3	9.4	8.1	7.1	6.3	
4	20	0.35	17.5	13.1	10.5	8.8	7.5	6.6	5.8
	25	0.40	19.6	14.7	11.7	9.8	8.4	7.3	6.5
	30	0.43	21.4	16.1	12.9	10.8	9.2	8.0	7.1
	35	0.47	23.2	17.4	13.9	11.6	9.9	8.7	7.7
	40	0.50	24.8	18.6	14.9	12.4	10.6	9.3	8.3
	50	0.56	27.7	20.8	16.6	13.9	11.9	10.4	9.2
60	0.61	30.3	22.8	18.2	15.2	13.0	11.4	10.1	
5	20	0.42	20.7	16.5	12.4	10.3	8.9	7.7	6.9
	25	0.47	23.1	17.3	13.9	11.5	9.9	8.7	7.7
	30	0.51	25.3	19.0	15.2	12.7	10.8	9.5	8.4
	35	0.55	27.3	20.5	16.4	13.7	11.7	10.2	9.1
	40	0.59	29.2	21.9	17.5	14.6	12.5	11.0	9.7
	50	0.66	32.7	24.5	19.6	16.3	14.0	12.2	10.9
60	0.72	35.8	26.9	21.5	17.9	15.3	13.4	11.9	
6	20	0.55	27.3	20.5	16.9	13.7	11.7	10.2	9.1
	25	0.62	30.6	22.9	18.3	15.3	13.1	11.5	10.2
	30	0.68	33.4	25.1	20.1	16.7	14.3	12.5	11.2
	35	0.73	36.1	27.1	21.7	18.1	15.5	13.5	12.0
	40	0.78	38.7	29.0	23.2	19.3	16.6	14.5	12.9
	50	0.87	43.2	32.4	25.9	21.6	18.5	16.2	14.4
60	0.96	47.3	35.5	28.4	23.6	20.3	17.7	15.8	

### CP-65T-SHP3 HIGH VOLUME

SPRAYER TURBO NOZZLE

Gallons per Acre **with Triple Stream Tip**  
20" Spacing Only

#10 Orifice Only	PSI	Nozzle Capacity GPM	6 MPH	8 MPH	10 MPH	12 MPH	14 MPH	16 MPH	18 MPH
#10	25	0.77	38.0	28.5	22.8	19.0	16.3	14.2	12.7
	30	0.84	41.6	31.2	25.0	20.8	17.8	15.6	13.9
	35	0.91	44.9	33.7	27.0	22.5	19.3	16.8	15.0
	40	0.97	48.0	36.0	28.8	24.0	20.6	18.0	16.0
	50	1.08	53.7	40.3	32.2	26.8	23.0	20.1	17.9
	60	1.19	58.8	44.1	35.3	29.4	25.2	22.1	19.6



# GPA Chart: CPF270T-5ST

## 5 Straight Stream Tip for CP-59s and CP-109s

### CP-59LS / CP-109LS - LOW VOLUME TURBO FLOATER NOZZLES

#### CPF270T-5ST - 5 STRAIGHT STREAM TIP

		Gallons Per Acre															
Orifice	PSI	Nozzle Capacity GPM	30" Spacing					40" Spacing					60" Spacing				
			10 MPH	12 MPH	14 MPH	16 MPH	18 MPH	10 MPH	12 MPH	14 MPH	16 MPH	18 MPH	10 MPH	12 MPH	14 MPH	16 MPH	18 MPH
2.5	30	0.5	9.90	8.25	7.07	6.19	5.50	7.43	6.19	5.30	4.64	4.13	4.95	4.13	3.54	3.09	2.75
	40	0.6	11.88	9.90	8.49	7.43	6.60	8.91	7.43	6.36	5.57	4.95	5.94	4.95	4.24	3.71	3.30
	50	0.7	13.86	11.55	9.90	8.66	7.70	10.40	8.66	7.43	6.50	5.78	6.93	5.78	4.95	4.33	3.85
5	30	1.2	23.76	19.80	16.97	14.85	13.20	17.82	14.85	12.73	11.14	9.90	11.88	9.90	8.49	7.43	6.60
	40	1.4	27.72	23.10	19.80	17.33	15.40	20.79	17.33	14.85	12.99	11.55	13.86	11.55	9.90	8.66	7.70
	50	1.6	31.68	26.40	22.63	19.80	17.60	23.76	19.80	16.97	14.85	13.20	15.84	13.20	11.31	9.90	8.80
7.5	30	1.4	27.72	23.10	19.80	17.33	15.40	20.79	17.33	14.85	12.99	11.55	13.86	11.55	9.90	8.66	7.70
	40	1.6	31.68	26.40	22.63	19.80	17.60	23.76	19.80	16.97	14.85	13.20	15.84	13.20	11.31	9.90	8.80
	50	1.8	35.64	29.70	25.46	22.28	19.80	26.73	22.28	19.09	16.71	14.85	17.82	14.85	12.73	11.14	9.90
10	30	2.2	43.56	36.30	31.11	27.23	24.20	32.67	27.23	23.34	20.42	18.15	21.78	18.15	15.56	13.61	12.10
	40	2.5	49.50	41.25	35.36	30.94	27.50	37.13	30.94	26.52	23.20	20.63	24.75	20.63	17.68	15.47	13.75
	50	2.7	53.46	44.55	38.19	33.41	29.70	40.10	33.41	28.64	25.06	22.28	26.73	22.28	19.09	16.71	14.85
15	30	3.0	59.40	49.50	42.43	37.13	33.00	44.55	37.13	31.82	27.84	24.75	29.70	24.75	21.21	18.56	16.50
	40	3.6	71.28	59.40	50.91	44.55	39.60	53.46	44.55	38.19	33.41	29.70	35.64	29.70	25.46	22.28	19.80
	50	3.8	75.24	62.70	53.74	47.03	41.80	56.43	47.03	40.31	35.27	31.35	37.62	31.35	26.87	23.51	20.90
20	30	3.2	63.36	52.80	45.26	39.60	35.20	47.52	39.60	33.94	29.70	26.40	31.68	26.40	22.63	19.80	17.60
	40	3.7	73.26	61.05	52.33	45.79	40.70	54.95	45.79	39.25	34.34	30.53	36.63	30.53	26.16	22.89	20.35
	50	4.1	81.18	67.65	57.99	50.74	45.10	60.89	50.74	43.49	38.05	33.83	40.59	33.83	28.99	25.37	22.55
24	30	3.7	73.26	61.05	52.33	45.79	40.70	54.95	45.79	39.25	34.34	30.53	36.63	30.53	26.16	22.89	20.35
	40	4.2	83.16	69.30	59.40	51.98	46.20	62.37	51.98	44.55	38.98	34.65	41.58	34.65	29.70	25.99	23.10
	50	4.7	93.06	77.55	66.47	58.16	51.70	69.80	58.16	49.85	43.62	38.78	46.53	38.78	33.24	29.08	25.85
30	30	3.9	77.22	64.35	55.16	48.26	42.90	57.92	48.26	41.37	36.20	32.18	38.61	32.18	27.58	24.13	21.45
	40	4.5	89.10	74.25	63.64	55.69	49.50	66.83	55.69	47.73	41.77	37.13	44.55	37.13	31.82	27.84	24.75
	50	4.8	95.04	79.20	67.89	59.40	52.80	71.28	59.40	50.91	44.55	39.60	47.52	39.60	33.94	29.70	26.40

\*Preliminary Data

### CP-59HV / CP-109HV - HIGH VOLUME TURBO FLOATER NOZZLES

#### CPF270T-5ST - 5 STRAIGHT STREAM TIP

		Gallons Per Acre															
Orifice	PSI	Nozzle Capacity GPM	30" Spacing					40" Spacing					60" Spacing				
			10 MPH	12 MPH	14 MPH	16 MPH	18 MPH	10 MPH	12 MPH	14 MPH	16 MPH	18 MPH	10 MPH	12 MPH	14 MPH	16 MPH	18 MPH
5	30	0.6	10.89	9.08	7.78	6.81	6.05	8.17	6.81	5.83	5.10	4.54	5.45	4.54	3.89	3.40	3.03
	40	0.6	12.38	10.31	8.84	7.73	6.88	9.28	7.73	6.63	5.80	5.16	6.19	5.16	4.42	3.87	3.44
	50	0.7	13.86	11.55	9.90	8.66	7.70	10.40	8.66	7.43	6.50	5.78	6.93	5.78	4.95	4.33	3.85
10	30	2.3	45.54	37.95	32.53	28.46	25.30	34.16	28.46	24.40	21.35	18.98	22.77	18.98	16.26	14.23	12.65
	40	2.6	51.48	42.90	36.77	32.18	28.60	38.61	32.18	27.58	24.13	21.45	25.74	21.45	18.39	16.09	14.30
	50	3.0	59.40	49.50	42.43	37.13	33.00	44.55	37.13	31.82	27.84	24.75	29.70	24.75	21.21	18.56	16.50
15	30	2.1	41.58	34.65	29.70	25.99	23.10	31.19	25.99	22.28	19.49	17.33	20.79	17.33	14.85	12.99	11.55
	40	2.5	49.50	41.25	35.36	30.94	27.50	37.13	30.94	26.52	23.20	20.63	24.75	20.63	17.68	15.47	13.75
	50	2.8	55.44	46.20	39.60	34.65	30.80	41.58	34.65	29.70	25.99	23.10	27.72	23.10	19.80	17.33	15.40
20	30	3.0	59.40	49.50	42.43	37.13	33.00	44.55	37.13	31.82	27.84	24.75	29.70	24.75	21.21	18.56	16.50
	40	3.5	69.30	57.75	49.50	43.31	38.50	51.98	43.31	37.13	32.48	28.88	34.65	28.88	24.75	21.66	19.25
	50	3.9	77.22	64.35	55.16	48.26	42.90	57.92	48.26	41.37	36.20	32.18	38.61	32.18	27.58	24.13	21.45
30	30	3.9	77.22	64.35	55.16	48.26	42.90	57.92	48.26	41.37	36.20	32.18	38.61	32.18	27.58	24.13	21.45
	40	4.5	89.10	74.25	63.64	55.69	49.50	66.83	55.69	47.73	41.77	37.13	44.55	37.13	31.82	27.84	24.75
	50	5.0	99.00	82.50	70.71	61.88	55.00	74.25	61.88	53.04	46.41	41.25	49.50	41.25	35.36	30.94	27.50
40	30	3.9	77.22	64.35	55.16	48.26	42.90	57.92	48.26	41.37	36.20	32.18	38.61	32.18	27.58	24.13	21.45
	40	4.5	89.10	74.25	63.64	55.69	49.50	66.83	55.69	47.73	41.77	37.13	44.55	37.13	31.82	27.84	24.75
	50	5.0	99.00	82.50	70.71	61.88	55.00	74.25	61.88	53.04	46.41	41.25	49.50	41.25	35.36	30.94	27.50
50	30	4.2	83.16	69.30	59.40	51.98	46.20	62.37	51.98	44.55	38.98	34.65	41.58	34.65	29.70	25.99	23.10
	40	4.7	93.06	77.55	66.47	58.16	51.70	69.80	58.16	49.85	43.62	38.78	46.53	38.78	33.24	29.08	25.85
	50	5.2	102.96	85.80	73.54	64.35	57.20	77.22	64.35	55.16	48.26	42.90	51.48	42.90	36.77	32.18	28.60
60	30	4.2	83.16	69.30	59.40	51.98	46.20	62.37	51.98	44.55	38.98	34.65	41.58	34.65	29.70	25.99	23.10
	40	4.8	95.04	79.20	67.89	59.40	52.80	71.28	59.40	50.91	44.55	39.60	47.52	39.60	33.94	29.70	26.40
	50	5.2	102.96	85.80	73.54	64.35	57.20	77.22	64.35	55.16	48.26	42.90	51.48	42.90	36.77	32.18	28.60

\*Preliminary Data



# CP Nozzles Setup, Use & Maintenance

Quality equipment gives an applicator and grower the edge over their competition. CP Nozzles get the drop to the crop while reducing the cost of replacement nozzles when properly maintained. Properly installing and maintaining the equipment is key to keeping a higher profit margin.

## Tips for Installing and Using CP Nozzles

- ✓ Do NOT use wrenches or any other tools on CP nozzles. Use hand pressure only when installing nozzles or check valves.
- ✓ Mount nozzle on boom so the arrow on the nozzle housing is on top and nozzle body is oriented between 0° and 45° parallel with ground.
- ✓ Use Teflon paste instead of Teflon tape. Teflon tape can contain tiny strands, which can cause drip problems.
- ✓ Check tension on each nozzle and check valve cap while installing. Selector-to-seal tension is pre-set and held by the stainless steel nut to cause heavy drag, allowing rotation of selectors while maintaining proper seal during rotation. Maintain this tension to keep seal and o-rings in clean condition. Check valve cap should be tight.
- ✓ Any deflector tip can be used with any orifice. However, maximum flow rate for any orifice can be no greater than the rate of the deflector tip.
- ✓ Check CP chart for flow rates. Determine desired GPM, appropriate orifice/deflector tip, pressure and speed for product label requirements and climatic conditions. Adjust orifice and deflector tip, pressure and boom height to give 10% overlap at the target

## Maintenance & Tune-Up Tips

Maintenance keeps all equipment functioning properly. All data presented on nozzles assume nozzles are new or well maintained. Suppose nozzles are worn out with altered orifices or chipped and cracked deflector surfaces. In that case, metering could be off, and patterns could be distorted.

Timely maintenance and replacement of nozzles, when necessary, is critical to nozzle performance. After each use, clean the sprayer to remove chemical residue by thoroughly flushing with tank cleaners and water inside and out. The following maintenance steps are especially recommended when liquid fertilizer has been used. Liquid fertilizer can be dry in enough to cause the detent to lock if not well lubricated.

1. **Remove the nozzle from the boom.**
2. **Holding the nozzle upright, remove the nut, deflector wheel, and selector (be careful not to lose the tiny detent ball or spring).**
3. **Blow out and clean the detent chamber and thoroughly wipe all debris and residue from the seal, selector, deflector wheel, and body.**
4. **Look for worn-out O-rings or scoring on the seal. If items look worn or scored, replace with new O-rings and seal.**
5. **Fill the detent chamber with marine bearing grease. Then, put the detent spring and ball back into the chamber.**
6. **Install the selector, deflector wheel, washer, and nut. Tighten the nut so there is a heavy drag on the seal (approximately 15 in.lbs.).**



# Quick List of Products

PN	Description
<b>Floater Nozzles (Pre-Emerge)</b>	
CP-59LS	¾" Cam Lock Low Volume Turbo Floater Nozzle: GPM range of .43 to 6.71 @ 30-50 psi (See Flow Chart for Orifice/Tip settings)
CP-59HV	¾" Cam Lock High Volume Turbo Floater Nozzle: GPM range of .87 to 13.42 @ 30-50 psi (See Flow Chart for Orifice/Tip settings)
CP-59's Custom	Custom Tip options for CP-59's are available. See "Turbo Floater/Sprayer Tips & Deflector" chart for tip options and select from floater tips. (Please indicate custom tip choice when ordering.)
CP-55R-3	¾" Cam Lock Medium Volume Floater Nozzle with Stainless Steel Orifice Selector & Stainless Steel 3-Way Deflector (GPM range of 1.00 to 12.00 @ 40psi)
<b>Combo Nozzles with Check Valves</b>	
CP-109LS	¾" Cam Lock Low Volume TURBO Combo Floater Nozzle: GPM range of .43 to 6.71 @ 30-50 psi (See Flow Chart for Orifice/Tip settings)
CP-109LS-AS	¾" Cam Lock Low Volume TURBO Combo Floater Nozzle with Air Stop Check Valve: GPM range of .43 to 6.71 @ 30-50 psi (See Flow Chart for Orifice/Tip settings)
CP-109HV	¾" Cam Lock High Volume TURBO Combo Floater Nozzle: GPM range of .87 to 13.42 @ 30-50 psi (See Flow Chart for Orifice/Tip settings)
CP-109HV-AS	¾" Cam Lock High Volume TURBO Combo Floater Nozzle with Air Stop Check Valve: GPM range of .87 to 13.42 @ 30-50 psi (See Flow Chart for Orifice/Tip settings)
CP-109's Custom	Custom Tip options for CP-109's are available. See "Turbo Floater/Sprayer Tips & Deflector" chart for tip options and select from floater tips. (Please indicate custom tip choice when ordering.)
CP-102R3	¾" Cam Lock Medium Volume Combo Floater Nozzle with Stainless Steel Orifice Selector & Stainless Steel 3-Way Deflector: GPM range of 1.00 to 12.00 @ 40 psi
<b>Sprayer Turbo Nozzles (Post-Emerge)</b>	
CP-65T-SL	¼ Turn Quick Disconnect Low Volume TURBO Sprayer Nozzle: GPM range of .13 to .67 @ 30-50 psi
CP-65T-S	¼ Turn Quick Disconnect Medium Volume TURBO Sprayer Nozzle: GPM range of .26 to 1.1 @ 30-50 psi
CP-65T-SHP	¼ Turn Quick Disconnect High Volume TURBO Sprayer Nozzle: GPM range of .87 to 3.3 @ 30-50 psi
CP-65T-SL3	¼ Turn Quick Disconnect Low Volume TURBO Sprayer Nozzle with Triple Stream Tip installed: GPM range of Triple Stream Tip .13 to .96 @ 30-60 psi
CP-65T-S3	¼ Turn Quick Disconnect Medium Volume TURBO Sprayer Nozzle with Triple Stream Tip installed: GPM range of Triple Stream Tip .19 to 1.35 @30-60psi
CP65T-SHP3	¼ Turn Quick Disconnect Medium Volume TURBO Sprayer Nozzle with Triple Stream Tip installed: GPM range of Triple Stream Tip .84 to 1.19@30-60psi
CP-74Q	¼ Turn Quick Disconnect 4 Tip Carousel Sprayer Nozzle: Tips installed are Customers Choice (See Tip Chart for Flow Rates & Tip options)
CP-74C	¾" Cam Lock 4 Tip Carousel Sprayer Nozzle: Tips installed are Customers Choice (See Tip Chart for Flow Rates & Tip options)
<b>Check Valves</b>	
CP-110C	¾" Cam Lock Inlet Check Valve
CP-110C-AS	¾" Cam Lock Inlet Air Stop Check Valve
CP-110P	¾" Pipe Inlet Check Valve
CP-110P-AS	¾" Pipe Inlet Air Stop Check Valve
CP-112SE 1"	Split Eye Check Valve for 1" Pipe
CP-112SE ¾"	Split Eye Check Valve for ¾" Pipe

Continued on Next Page

PN	Description
<b>Spray Accessories</b>	
CP-80C	¾" Cam Lock 90° Elbow
CP-80P	¾" Threaded Pipe 90° Elbow
CP-80P1	1" Threaded Pipe 90° Elbow
CP-81C	¾" Cam Lock 45° Elbow
CP-81P	¾" Threaded Pipe 45° Elbow
CP-81P1	1" Threaded Pipe 45° Elbow
CP-49	Poly Filter Screen with 50mesh Stainless Steel Screen for ¾" male threaded and Cam Lock Connections. Easy to remove and clean!
CPF2751	Adaptor - for mounting a quarter-turn specialized or certified tip to the CP® Floater Turbo nozzles
CPS2751	Adaptor - for mounting a quarter-turn specialized or certified tip to the CP® Sprayer Turbo nozzles

# Quick List of Replacement Parts

## Check Valve Poppet

CP212-F	Large Check Valve Poppet Assembled
CP212-FAS	Air Stop Poppet Conversion Kit
CP212-A	Small Check Valve Poppet Assembled
CPF212	Large Check Valve Poppet Stem ONLY
CPA212	Small Check Valve Poppet Stem ONLY

## Detent Ball & Springs

CP377	Stainless Steel Detent Ball (Each)
CP377P	Stainless Steel Detent Ball Pack (50pcs)
CP376	Stainless Steel Detent Spring (each)
CP376P	Stainless Steel Detent Spring Pack (50pcs)
CP320	Stainless Steel Spring each)
CP320	Stainless Steel Spring Pack (50pcs)
CP319	Stainless Steel Spring (each)
CP319P	Stainless Steel Spring Pack (50pcs)
CP319HD	Stainless Steel Spring (each)
CP319HDP	Stainless Steel Spring Pack (50pcs)
CP319-XD	Stainless Steel Xtreme Duty Spring (23 lb)

## E-Ring, Nuts, & Washers

CP316	Stainless Steel E-Ring (each)
CP316P	Stainless Steel E-Ring Pack (50pcs)
CPF289	Teflon Washer (each)
CPF289P	Teflon Washer Pack (50pcs)
CP388	Stainless Steel Washer (each)
CP388P	Stainless Steel Washer Pack (50pcs)
CP387	Stainless Steel Locking Nut (each)
CP387P	Stainless Steel Locking Pack (50pcs)
CP390	#6 Pan Nut with lock washer (each)
CP390P	#6 Pan Nut with lock washer Pack (50pcs)
CP391	#6 Phil Pan Screw (each)
CP391P	#6 Phil Pan Screw Pack (50pcs)
CP392	#8 Phil Pan Screw (each)
CP392P	#8 Phil Pan Screw Pack (50pcs)
CP393	#8 Phil Pan Screw (each)
CP393P	#8 Phil Pan Screw Pack (50pcs)

## Gaskets

CP363	3/4" EPDM Gasket
CP364	1/8" EPDM Gasket
CP365	3/16" EPDM Gasket
CP366	9/64" EPDM Gasket

Continued on Next Page

## Nozzle Body & Cap

CPF250-BE	3/4" Cam Lock Low Volume Floater Body
CPF250-HV	3/4" Cam Lock High Volume Floater Body
CPF250-Q	1/4 Turn Quick Disconnect Body
CPF102-B	3/4" Cam Lock Low Volume Combo Body
CPF102-HV	3/4" Cam Lock High Volume Combo Body
CPF102-C	Poly Combo Cap
CPF102-CAS	Air Stop Cap
CPF115-B3/4"	3/4" Split Eyelet Check Valve Body
CPF115-B 1"	1" Split Eyelet Check Valve Body
CPF115-CL 3/4"	3/4" Split Eyelet Clamp
CPF115-CL 1"	1" Split Eyelet Clamp
CPF204-CN	Split Eyelet Check Valve Cap
CPS165BQN	1/4 Turn Quick Disconnect Turbo Sprayer Body

## O-Rings

CP318-08	Viton O-Ring #8 (each)
CP318-08P	Viton O-Ring #8 Pack (50pcs)
CP318-10	Viton O-Ring #10 (each)
CP318-10P	Viton O-Ring #10 Pack (50pcs)
CP318-11	Viton O-Ring #11 (each)
CP318-11P	Viton O-Ring #11 Pack (50pcs)
CP318-13	Viton O-Ring #13 (each)
CP318-13P	Viton O-Ring #13 Pack (50pcs)
CP318-13H	Viton O-Ring #13H (each)
CP318-13HP	Viton O-Ring #13H Pack (50pcs)
CP318-14	Viton O-Ring #14 (each)
CP318-14P	Viton O-Ring #14 Pack (50pcs)
CP318-110	Viton O-Ring #110 (each)
CP318-110P	Viton O-Ring #110 Pack (50pcs)

## Selector

CPF281T-L1	Poly Low Volume Turbo Floater Selector
CPF281T-HVC	Poly High Volume Turbo Combo Floater Selector
CPF281T-HVF	Poly High Volume Turbo Floater Selector
CPF283-R	Stainless Steel Medium Volume Selector
CPS281T-L	Poly Low Volume Turbo Sprayer Selector
CPS281T	Poly Medium Volume Turbo Sprayer Selector
CPS281T-HV	Poly High Volume Turbo Sprayer Selector

## Tip Wheel & Washer

CPF285-T	Poly Low Volume Turbo Floater Tip Wheel
CPF285-HVT	Poly High Volume Turbo Floater Tip Wheel
CPS285-T	Poly Turbo Sprayer Tip Wheel
CPF256T	Poly Low Volume Turbo Floater Tip Washer
CPF256THV	Poly High Volume Turbo Floater Tip Washer
CPA244-SP	Poly Seal Plate

## Turbo Floater/Sprayer Tips & Deflector

CPF270T-5	Stainless Steel Turbo Floater Tip #5
CPF270T-7.5	Stainless Steel Turbo Floater Tip #7.5
CPF270T-10	Stainless Steel Turbo Floater Tip #10
CPF270T-12	Stainless Steel Turbo Floater Tip #12
CPF270T-15	Stainless Steel Turbo Floater Tip #15
CPF270T-18	Stainless Steel Turbo Floater Tip #18
CPF270T-30	Stainless Steel Turbo Floater Tip #30
CPF270T-35	Stainless Steel Turbo Floater Tip #35
CPF270T-60	Stainless Steel Turbo Floater Tip #60
CPF270T-60HV	Stainless Steel Turbo Floater Tip #60HV
CPF282-R3	Stainless Steel 3-Way Deflector
CPS270TP-2	Poly Turbo Sprayer Tip #2
CPS270TP-3	Poly Turbo Sprayer Tip #3
CPS270TP-4	Poly Turbo Sprayer Tip #4
CPS270TP-6	Poly Turbo Sprayer Tip #6
CPS270TP-7.5	Poly Turbo Sprayer Tip #7.5
CPS270TP-10	Poly Turbo Sprayer Tip #10
CPS270TP-15	Poly Turbo Sprayer Tip #15
CPS270TP-25	Poly Turbo Sprayer Tip #25
CPS270TP-33	Poly Turbo Sprayer Tip #33
CPS275T-3SS1	Triple Stream Accessory tip for Turbo Sprayers
CPF270T-5ST1	Turbo Floater Tip - 5 Stream Tip

## Viton-Diaphragm/ Teflon /Seals

CPA310T	Split Eyelet Check Valve Teflon Diaphragm (Each)
CPA310-TP	Split Eyelet Check Valve Teflon Diaphragm Pack (50pcs)
CPA310V	Split Eyelet Check Valve Viton Diaphragm (Each)
CPA310-VP	Split Eyelet Check Valve Viton Diaphragm Pack (50pcs)
CPF310-TC	Combo Check Valve Teflon Diaphragm (Each)
CPF310-TCP	Combo Check Valve Teflon Diaphragm Pack (50pcs)
CPF310-VC	Combo Check Valve Viton Diaphragm (Each)
CPF310-VCP	Combo Check Valve Viton Diaphragm Pack (50pcs)
CPF310-VC-AS	Air Stop Diaphragm (Each)
CPF310-VC-ASP	Air Stop Diaphragm Pack (50pcs)
CPF286-E	Low Volume Teflon Seal (Each)
CPF286-E-P	Low Volume Teflon Seal Pack (50pcs)
CPF286-HV	High Volume Teflon Seal (Each)
CPF286-HVP	High Volume Teflon Seal Pack (50pcs)
CPS286	Turbo Sprayer Teflon Seal (Each)
CPS286-P	Turbo Sprayer Teflon Seal Pack (50pcs)

# Dealer List

## Alabama

AG Spray Equipment - Dothan  
[www.agspray.com](http://www.agspray.com)

## California

AG Spray Equipment - Bakersfield  
[www.agspray.com](http://www.agspray.com)

## Colorado

Fairbank Equipment Inc - Evans  
[www.fairbankequipment.com](http://www.fairbankequipment.com)

## Georgia

Newton Crouch Inc - Griffin  
[www.newtoncrouch.com](http://www.newtoncrouch.com)

## Idaho

Heartland Ag Systems - Burley  
[www.heartlandag.com](http://www.heartlandag.com)

## Illinois

AGCO Parts Division - West Chicago  
[www.agcoparts.com](http://www.agcoparts.com)

AGRO-CHEM Inc - Saybrook  
[www.agrochem.com](http://www.agrochem.com)

Altorfer Ag Products  
[www.altorferag.com](http://www.altorferag.com)

1. Clinton: 877-228-7278

2. Rock Falls: 815-535-0881

Fertilizer Dealer Supply - Philo  
[www.fertilizerdealer.com](http://www.fertilizerdealer.com)

Jenner Sales Corp - Harristown  
[www.jennerag.com](http://www.jennerag.com)

Linco Precision LLC - El Paso  
[www.lincoprecision.com](http://www.lincoprecision.com)

Precision Tank & Equipment - Athens

[www.precisiontank.com](http://www.precisiontank.com)

## Indiana

AGRO-CHEM Inc - Wabash  
[www.agrochem.com](http://www.agrochem.com)

Fertilizer Dealer Supply - Brookston  
[www.fertilizerdealer.com](http://www.fertilizerdealer.com)

## Iowa

Dultmeier Sales - Davenport  
[www.dultmeier.com](http://www.dultmeier.com)

Fertilizer Dealer Supply - Jesup  
[www.fertilizerdealer.com](http://www.fertilizerdealer.com)

Heartland Ag Systems - Ames  
[www.heartlandag.com](http://www.heartlandag.com)

The Gator Center - Fort Dodge  
[www.thegatorcenter.com](http://www.thegatorcenter.com)

## Kansas

AG Spray Equipment - Newton  
[www.agspray.com](http://www.agspray.com)

B Z Bee, Inc. - Lyons  
[www.bzbees.com](http://www.bzbees.com)

## Fairbank Equipment Inc -

[www.fairbankequipment.com](http://www.fairbankequipment.com)

1. Garden City

2. Wichita

Heartland Ag Systems - Great Bend  
[www.heartlandag.com](http://www.heartlandag.com)

Lang Diesel, Inc.  
[www.agcoequipment.com/lang-diesel](http://www.agcoequipment.com/lang-diesel)

1. Chanute: 620-431-6700

2. Colby: 785-462-2412

3. Ellinwood: 620-564-2255

4. Garden City: 620-260-9379

5. Hays: 785-735-2651

6. Hillsboro: 620-947-3182

8. Smith Center: 785-282-6861

9. South Hutchinson: 620-665-6565

10. Topeka: 866-804-3276

Parallel AG - Liberal

[www.parallelag.com](http://www.parallelag.com)

## Kentucky

AG Spray Equipment - Hopkinsville  
[www.agspray.com](http://www.agspray.com)

## Michigan

Fertilizer Dealer Supply - Morrice  
[www.fertilizerdealer.com](http://www.fertilizerdealer.com)

## Minnesota

Abner Sales - Benson

[www.abnersales.com](http://www.abnersales.com)

AG Spray Equipment - Mankato  
[www.agspray.com](http://www.agspray.com)

Heartland Ag Systems - Hutchinson  
[www.heartlandag.com](http://www.heartlandag.com)

## Mississippi

AG Spray Equipment - Greenwood  
[www.agspray.com](http://www.agspray.com)

Wade Incorporated  
[www.wadeincorporated.com](http://www.wadeincorporated.com)

1. Batesville: 662-561-0046

2. Boyle: 662-843-5321

3. Clarksdale: 662-624-4336

4. Columbus: 662-241-4318

5. Corinth: 662-287-4494

6. Greenwood: 662-453-6312

7. Grenada: 662-226-4521

8. Hernando: 662-429-4483

9. Indianola: 662-887-4751

10. Leland: 662-332-8108

11. Pontotoc: 662-489-1381

12. Tunica: 662-363-2622

13. Vardaman: 662-682-9550

14. Webb: 662-375-8121

## Missouri

Fertilizer Dealer Supply - Boonville  
[www.fertilizerdealer.com](http://www.fertilizerdealer.com)

Heartland Ag Systems - Marshall  
[www.heartlandag.com](http://www.heartlandag.com)

## Montana

Heartland Ag Systems - Great Falls  
[www.heartlandag.com](http://www.heartlandag.com)

## Nebraska

AG Spray Equipment - Columbus  
[www.agspray.com](http://www.agspray.com)

Butler Machinery - Kearney  
[www.buttermachinery.com](http://www.buttermachinery.com)

Dultmeier Sales - Omaha

[www.dultmeier.com](http://www.dultmeier.com)

Fairbank Equipment Inc - Grand Island

[www.fairbankequipment.com](http://www.fairbankequipment.com)

Heartland Ag Systems - Grand Island

[www.heartlandag.com](http://www.heartlandag.com)

Select Sprayers & Equipment - Kearney

[www.selectsprayers.com](http://www.selectsprayers.com)

## North Dakota

AG Spray Equipment - Fargo

[www.agspray.com](http://www.agspray.com)

Heartland Ag Systems - Garrison

[www.heartlandag.com](http://www.heartlandag.com)

Heartland Ag Systems - Manvel

[www.heartlandag.com](http://www.heartlandag.com)

## Ohio

AGRO-CHEM Inc - Wilmington  
[www.agrochem.com](http://www.agrochem.com)

Fertilizer Dealer Supply - Anna  
[www.fertilizerdealer.com](http://www.fertilizerdealer.com)

## Oklahoma

Fairbank Equipment Inc - Chandler  
[www.fairbankequipment.com](http://www.fairbankequipment.com)

Parallel AG  
[www.parallelag.com](http://www.parallelag.com)

1. Chickasha

2. Fairview

Wylie Spray Center - Oklahoma City,  
[www.wyiesprayers.com](http://www.wyiesprayers.com)

## Pennsylvania

GVM Distribution - Biglerville  
[www.gvmdat.com](http://www.gvmdat.com)

## South Dakota

C & R Supply, Inc. - Sioux Falls  
[www.crsupply.com](http://www.crsupply.com)

Fairbank Equipment Inc - Yankton  
[www.fairbankequipment.com](http://www.fairbankequipment.com)

Heartland Ag Systems - Mitchell  
[www.heartlandag.com](http://www.heartlandag.com)

## Texas

Martinek Grain Bins Inc - Gunter  
903-433-5425

## Parallel AG

[www.parallelag.com](http://www.parallelag.com)

1. Dalhart: 806-884-4740

2. Amarillo: 855-335-2861

3. Brownsville:

## Wylie Implement & Spray Center

[www.wyiesprayers.com](http://www.wyiesprayers.com)

1. Abilene: 800-588-7100

2. Amarillo: 855-335-2861

3. Brownsville: 844-550-8822

4. Corpus Christi: 844-526-7284

5. Edinburg: 800-514-9381

6. El Campo: 800-474-2416

7. Hewitt: 800-803-5845

8. Lamesa: 877-308-9685

9. Lubbock: 800-722-4001

10. Lubbock: 888-249-5162

11. Munday: 800-338-2401

12. Plainview: 855-293-4116

13. Raymondville: 844-689-2137

14. Seminole: 888-758-1181

## Washington

AG Spray Equipment - Othello  
[www.agspray.com](http://www.agspray.com)

Heartland Ag Systems - Moses Lake  
[www.heartlandag.com](http://www.heartlandag.com)

## Wisconsin

Fertilizer Dealer Supply - Milton  
[www.fertilizerdealer.com](http://www.fertilizerdealer.com)

Heartland Ag Systems - DeForest  
[www.heartlandag.com](http://www.heartlandag.com)